

HP

PCL/PJL

Reference

**PCL 5 Color
Technical Reference
Manual**

PCL 5 Color Technical Reference Manual



Notice

The information contained in this document is subject to change without notice.

Copyright and License

Copyright © 1999
Hewlett-Packard Company.

All rights are reserved. This document contains proprietary information which is protected by copyright. Except as allowed by copyright laws or herein, reproduction, adaptation, or translation without prior written permission is prohibited.

Trademarks

Adobe, *PostScript*, and the PostScript logo are trademarks of Adobe Systems Incorporated which may be registered in certain jurisdictions. *AppleTalk* is a registered trademark of Apple Computer, Inc. *PCL* and *Resolution Enhancement* are registered trademarks of Hewlett-Packard Company. *IBM* is a registered trademark of International Business Machines Corporation.

Inside This Manual

What You Can Learn From This Manual

This manual describes the PCL 5 commands used to print color on the HP Color LaserJet printer family and the other Hewlett-Packard PCL 5 color printers. Some of the main topics include an overview of the color printing process, using palettes, choosing color modes, adjusting output color to meet your requirements, printing color raster graphics, and HP-GL/2 vector graphics. Examples are provided which demonstrate the use of the PCL 5 color commands.

Note

All commands described in this manual are not necessarily supported by all printers. See the *PCL 5 Comparison Guide* for feature support information for each printer.

This manual is written primarily for users that are already familiar with PCL 5 printer features. For information on using PCL 5, see the *PCL 5 Printer Language Technical Reference Manual*.

Manual Organization

This manual contains seven chapters and four appendices. Chapters 2 through 4 describe command usage for the HP Color LaserJet 4500 and 8500 printers. Appendices A through D describe how these functions are achieved on the HP Color LaserJet, Color LaserJet 5, 5M, and the DeskJet 1200C and 1600C printers. Chapters 5 through 7 pertain to all the color printers described in this manual. A brief description of each chapter is provided below.

Chapter 1. Color Printing Overview

This chapter explains background information about printing color documents using PCL 5. Topics include palettes, color selection, pixel encoding, color modes, and color matching.

Chapter 2. Using Color Modes

Chapter 2 defines the color modes and describes how to use them, including descriptions of sending color raster data using different pixel encoding modes and color spaces.

Chapter 3. Using Palettes

This chapter describes the palettes associated with the color modes and explains how palettes are created, saved, and modified.

Chapter 4. Modifying Output Color

This chapter explains the options for modifying the output color: the Render Algorithm command, the Monochrome Print Mode command, Driver Configuration command, and Finish Mode command.

Chapter 5. The PCL Print Model

Chapter 5 describes the print model and how it determines the printed outcome when various patterns, colors, and images are applied together on a page. This chapter discusses the role that logical operations and transparency modes have on this process.

Chapter 6. Raster Graphics

This chapter describes the raster graphics commands and also compressing raster graphics images using various compression methods.

Chapter 7. Color Vector Graphics (HP-GL/2)

This chapter discusses printing color pages using HP-GL/2, the vector graphics language included on all PCL 5 printers. The chapter describes new and/or modified HP-GL/2 commands and how they are used to print with HP color printers.

Appendix A. Color Printing Overview (Color LaserJet, 5, 5M, DeskJet)

Appendix A explains background information about printing color documents using PCL 5. Topics include palettes, device-dependent vs. device-independent color, color selection, pixel encoding, color modes, and color matching.

Appendix B. Using Color Modes (Color LaserJet, 5, 5M, DeskJet)

Appendix B defines the color modes for the HP Color LaserJet, Color LaserJet 5, 5M, and the DeskJet 1200C and 1600C printers, and describes how to use them. It includes descriptions of sending color raster data using different pixel encoding modes and color spaces.

Appendix C. Using Palettes (Color LaserJet, 5, 5M, DeskJet)

Appendix C describes the use of palettes for the HP Color LaserJet, 5, and 5M, and DeskJet 1200C and 1600C printers. It explains the palettes associated with the color modes and explains how palettes are created, saved, and modified.

Appendix D. Modifying Output Color (Color LaserJet, 5, 5M, DeskJet)

Appendix D describes how to modify output color for the HP Color LaserJet, Color LaserJet 5, 5M, and the DeskJet 1200C and 1600C printers. This chapter explains how color can be optimized by compensating for different conditions, such as variations in color due to light sources, limitations of the original artwork and variations in viewing monitors. The chapter details the use of halftone rendering algorithms, color lookup tables, gamma correction, and viewing illuminant commands. These commands are provided so that users can request and receive color output that matches their expectations.

Index

An index offers quick access to PCL command information.

Related Documents

The following documents provide related information about Hewlett-Packard PCL 5 printers.

PCL 5 Printer Language Technical Reference Manual

The *PCL 5 Printer Language Technical Reference Manual* provides a description of the printer command language that controls PCL 5 printers. The manual provides explanations of each PCL command, and has examples demonstrating how the commands are used to manipulate the printer. A large portion of the manual is devoted to HP-GL/2, the vector-based graphics language in PCL 5 printers.

PCL 5 Comparison Guide

This document provides printer-specific information on paper handling, internal fonts, PCL command support, and control panel information. It identifies feature differences between the various PCL 5 printers, and how the printers implement the commands described in the *PCL 5 Printer Language Technical Reference Manual*.

Printer Job Language Technical Reference Manual

This manual describes PJP, the HP printer job language used on many of the Hewlett-Packard printers. PJP is used for switching printer languages, requesting status information, changing display messages, inquiring about feature settings, and other job-level functions.

PCL/PJP Technical Quick Reference Guide

This booklet is designed to provide quick access to the syntax of each PCL and PJP command. The commands are grouped by their function so that those familiar with PCL and/or PJP can find the syntax of a specific command without opening the manual.

Contents

PCL 5 Color Technical Reference Manual

Inside This Manual	iii
Manual Organization	iv
Related Documents	vi

Chapter 1 Color Printing Overview

Introduction	1-1
Working with color documents	1-2
PCL 5 Color Concepts	1-3
Color	1-3
Color Specifications and Color Spaces	1-3
Color Management and the Standard Red, Green, Blue Color Space	1-4
Palettes and Color Selection	1-6
PCL 5 Color Graphics Context	1-6
PCL 5 Color Mode	1-6
PCL 5 Raster Images	1-7
Pixels and Pixel Encoding	1-7
Well-Behaved Raster	1-9

Chapter 2 Using Color Modes

Introduction	2-1
Simple Color Mode	2-3
PCL Imaging Mode	2-5
Configure Image Data (CID) Command	2-5
HP-GL/2 Imaging Mode	2-13

Chapter 3 Using Palettes

Introduction	3-1
Saving the Palette	3-3
Push/Pop Palette Command	3-3
Palette Management by ID	3-5
Select Palette Command	3-6
Palette Control ID	3-8
Palette Control	3-9
Simple Color Palettes	3-11

CID Color Palettes	3-13
Device RGB and sRGB Palettes	3-13
Device CMY Palettes	3-14
HP-GL/2 Palettes	3-15
Foreground Color	3-17
Foreground Color Command	3-17
Programming Color Palettes	3-19

Chapter 4 Modifying Output Color

Introduction	4-1
Halftone Render Algorithms	4-2
Render Algorithm Command	4-2
Monochrome Printing	4-3
Monochrome Print Mode Command	4-3
Driver Configuration Command	4-4
Finish Mode Command	4-6

Chapter 5 The PCL Print Model

Introduction	5-1
Command Sequence	5-6
Source Transparency Mode Command	5-7
Pattern Transparency Mode Command	5-8
Logical Operations	5-9
Logical Operations and Transparency Interactions	5-12
Logical Operation Command	5-13
ROPs in the RGB Color Space	5-14
ROPs in the CMY Color Space	5-15
Using a ROP	5-16
Table of Logical Operations	5-18
Pixel Placement	5-24
Pixel Placement Command	5-27
Filling with Patterns	5-28
Pattern ID (Area Fill ID) Command	5-29
Select Current Pattern Command	5-32
User-Defined Pattern Graphics	5-33
Using User-Defined Patterns	5-33
How the Printer Tiles a Pattern	5-34
Pattern Reference Point	5-36
Download Pattern Command	5-38
User-defined Pattern Example	5-40
Set Pattern Reference Point Command	5-43
Pattern Control Command	5-44
Rectangular Area Fills (Rules)	5-45
Pattern Transparency for Rectangular Area Fill	5-50

Rectangular Fill Examples	5-52
Solid Fill (Black/White)	5-52
Shaded Fill	5-54

Chapter 6 Raster Graphics

Introduction	6-1
PCL 5 Color Raster Graphics	6-4
Raster Graphics Command Sequence	6-6
Raster Graphics Resolution Command	6-8
Raster Graphics Presentation Mode Command	6-10
Source Raster Height Command	6-13
Source Raster Width Command	6-15
Start Raster Graphics Command	6-17
Raster Y Offset Command	6-19
Set Compression Method Command	6-20
Unencoded (Method 0)	6-21
Run-length Encoding (Method 1)	6-21
Tagged Image File Format Encoding (Method 2)	6-21
Delta Row Compression (Method 3)	6-24
Adaptive Compression (Method 5)	6-28
Transfer Raster Data Commands	6-32
Transfer Raster Data by Plane	6-33
Transfer Raster Data By Row/Block Command	6-33
End Raster Graphics Command	6-35
Raster Scaling	6-36
Raster Graphics Example	6-38
Color Raster Graphics Example	6-42

Chapter 7 Color Vector Graphics (HP-GL/2)

Introduction	7-1
Enter HP-GL/2 Mode	7-2
MC (Merge Control)	7-6
PC (Pen Color)	7-14
NP (Number of Pens)	7-17
CR (Color Range)	7-19
PP (Pixel Placement)	7-20

Appendix A Color Printing Overview (Color LaserJet, 5, 5M, DeskJet)

Introduction	A-1
Color Concepts	A-3
Palettes	A-3
Raster Mode	A-3
Raster Color vs. Non-Raster Color	A-3
Device-Dependent vs. Device-Independent Color	A-4
Black and White References	A-4
Color Selection	A-5
Pixel Encoding	A-6
Encoding by Plane	A-6
Color Modes	A-7
Device-Dependent Color Spaces	A-8
Device-Independent Color Spaces	A-8
Device-Independent Color	A-10
Device-Dependent Color	A-10
Device-Independent Color	A-10
Color Matching	A-11
Processing Color Documents	A-14
Non-Raster Color vs. Raster Color	A-14
Color Raster Data	A-14

Appendix B Using Color Modes (Color LaserJet, 5, 5M, DeskJet)

Introduction	B-2
Simple Color Mode	B-4
PCL Imaging Mode	B-6
Configure Image Data (CID) Command	B-6
Short Form of CID Command (Configure Image Data)	B-15
Long Form of CID Command (Configure Image Data)	B-17
HP-GL/2 Imaging Mode	B-28

Appendix C Using Palettes (Color LaserJet, 5, 5M, DeskJet)

Introduction	C-1
Saving the Palette	C-3
Push/Pop Palette Command	C-3
Palette Management by ID	C-5
Palette Control ID	C-8
Palette Control	C-9
Simple Color Palettes	C-11
CID Color Palettes	C-13
HP-GL/2 Palettes	C-16
Foreground Color	C-18

Programming Color Palettes	C-20
Color Component One	C-20
Color Component Two	C-20
Color Component Three	C-21
Assign Color Index	C-21

Appendix D Modifying Output Color (Color LaserJet, 5, 5M, DeskJet)

Introduction	D-1
Halftone Render Algorithms	D-3
Render Algorithm Command	D-3
User-Defined Dithers	D-6
Download Dither Matrix Command	D-7
Multiple Dither Matrices	D-10
Color Lookup Tables	D-13
Gamma Correction	D-17
Viewing Illuminant	D-18
Monochrome Printing	D-20
Driver Configuration Command	D-21

Index

1 Color Printing Overview

Introduction

This chapter provides an overview of color printing with Hewlett-Packard printers. A primary goal for HP color printers has always been WYSIWYG (What You See Is What You Get) color, where the color displayed on the screen while creating a document is the same as the color in the printed document. However, this goal has been very difficult to realize due to a number of factors such as:

- Some colors that can be shown on a computer display cannot be reproduced by a printer.
- The Cyan, Magenta, and Yellow colors used to create the colors specified in a document can differ in hue and quality from printer to printer, even printers from the same manufacturer. Furthermore, the colors produced by a given printer can change over time, due to internal changes as well as temperature and humidity.

Until recently, these and other problems have led HP to approach color matching by presenting a PCL 5 color command set giving users the ability to make both major and minor color print quality adjustments.

However, the emergence of sRGB (standard Red Green Blue) as an international color data standard and the growing sophistication of Hewlett-Packard printers has allowed HP to provide high quality WYSIWYG color documents with a much simpler PCL color command set. Therefore, this manual has two main parts: Chapters 1 through 7 present the latest, simplified PCL 5 color command set, and the appendices describe the command set described in Chapters 1 through 4 as they are supported by the Color LaserJet, Color LaserJet 5, DeskJet 1200C, and DeskJet 1600C printers. Chapters 5 – 7 pertain to both sets of printers.

Working with color documents

A document can be thought of as a series of text characters, vector graphics objects and images. The parts of a document either have color specifications in them, as do color images, or have color specifications applied to them, as do color vectors or text. For color images, the PCL 5 command set provides a way to specify the color format so that the image data can be interpreted correctly. For vector graphics and text, the PCL 5 color commands support the application of a color from a palette of colors.

Each color printed is synthesized from a combination of three colors: Cyan, Magenta, and Yellow. The way the three colors are combined to produce the desired color is called a half-tone, and the PCL 5 color command, Render Algorithm, specifies which half-tone to use for a color. Advances in Hewlett-Packard printers have allowed HP to reduce the number of render algorithms to Best, High, and Low. While the actual implementation of each of these algorithms may vary from printer to printer, HP has determined that the three algorithms are sufficient to produce high quality color documents containing text and graphics.

The colors that appear on a page also have one of two color treatments applied to them:

- 1 Screen Match (sRGB), which provides the best WYSIWYG color. This is the default color treatment.
- 2 The Vivid color treatment, which provides access to the entire device gamut (range of colors the printer can produce). However, these colors are less correlated to those shown on a monitor than colors that have had the Screen Match treatment applied.

The following factors form the heart of the PCL color graphics state:

- The palette of colors to be used in a document
- The render algorithm to print the colors
- The color treatment to be applied to each color

Palettes of colors can be referenced by an ID, and so can PCL color graphic states. At any given time there is an active palette to apply colors from, along with a render algorithm and color treatment to be applied to the colors. Palettes and their associated render algorithm and color treatment can be stored and retrieved using a palette ID. When a palette is retrieved and made the active palette, the render algorithm and color treatment stored with the palette are set as the current render algorithm and color treatment.

The PCL language also allows users to use patterns in combination with colors. These patterns and colors can be combined with text, vector graphics, and images to create new, complex graphics objects. The PCL Print Model determines the logical operations (known as ROPs, Raster Operations) used to combine each part of the graphic object.

PCL 5 Color Concepts

This section describes some of the concepts and terminology of color science related to the PCL 5 color commands.

Color

Color is a combination of human physiological and psychological responses to a relatively narrow band of frequencies in the electromagnetic spectrum. The frequencies visible to the human eye are called the visible spectrum. It's useful to understand that color comes both from direct light and indirect light that has reflected from a surface. Reflected light absorbs all but the reflected frequency. The colors seen on a color monitor are combinations of different-colored lights traveling directly to the eye. They are called additive colors since the different colors combine to form the resulting color. The colors seen on a printed material such as paper are reflected from the paper surface, which absorbs some of the light. Colors seen under these conditions depend on the viewing conditions, the amount and color of ambient light, as well as the amount and color of the reflected light.

Color Specifications and Color Spaces

A given color can be described as particular amounts of three light frequencies (red, green, and blue light). For example, equal amounts of red, green, and blue light are perceived as white light. The absence of all three primary light colors is black.

Color can be described in ways other than amounts of red, green, and blue light. Generally, these color specification systems are known as color spaces. For example, The Cyan, Magenta, Yellow (CMY) color space is used to describe colors that are printed by depositing varying amounts of these three ink pigments (Cyan, Magenta, Yellow). The absence of pigment is considered to be white, and the presence of all three is black. The CMYK color space is similar to the CMY color space, but black pigment is used in place of 100% C, M, Y since imperfections in the hues of the C, M, Y pigments yield a dark brown rather than black.

A color specification, then, depends on the color space as well as the values used to describe a given color. Black in the RGB color space is described using the three numbers (0, 0, 0), but in the CMY color space it is described as (100, 100, 100), where the values are percentages of each color.

Color Management and the Standard Red, Green, Blue Color Space

For color to be reproduced in a predictable manner across different devices and materials, it has to be described in a way that is independent of the specific mechanisms and materials used to produce it. For instance, color displays and color printers use very different mechanisms for producing color. Traditionally, operating systems have supported color by declaring support for a particular color space (RGB in most cases). However, since the interpretation of RGB values varies between devices, color was not reliably reproduced across different devices.

The needs of the very high-end publishing sector could not be met by the traditional means of color support, so the various computer operating systems added support for using International Color Consortium (ICC) profiles to characterize device-dependent colors in a device-independent way. They used the profiles of the input device that created an image, and the output device that displayed or printed the image, to create a transform that moved the image from the color space of the input device to that of the output device. This resulted in very accurate color and access to the entire color gamut of both devices. However, it also involved the overhead of transporting the profile of the input device with the image and running the image through the transform.

Note

HP's ICC profiles are available through normal HP software distribution channels. For those who want the additional control available through building their own ICC profiles, there are several vendors of profiling tools available. To provide access to the printer's pure primaries and entire available printer gamut, the Vivid mode may be used when profiling the printer, and subsequently when using the ICC workflow.

However, there are a broad range of users that do not require this level of flexibility and control in an embedded color profile mechanism. Instead it is possible to define a single, standard default color space for exchange and interpretation of color data. Additionally, most existing file formats do not support color profile embedding, and may never do so. There is also a broad range of uses that actually discourages people from appending any extra data to their files. The sRGB color space addresses these issues.

The sRGB color space maintains the advantage of a clear relationship with ICC color management systems while minimizing software processes and support requirements. Since the image is in a known color space and the profile for that color space is included within the operating system and display application, this enables end-users to enjoy the benefits of color management without the overhead of larger files. Application developers and users who do not want the overhead of embedding profiles in documents or images should convert them to sRGB. While it may be that profiles buy slightly higher color accuracy, the benefits of using a standard color space far outweigh the drawbacks for a wide range of users. The migration of devices to support the standard color space (sRGB) natively will further enhance the speed and quality of the user experience.

The international standard color space sRGB (IEC 61966-2-1) is designed to complement current color management strategies by enabling a simple, robust method of handling color in the operating systems, device drivers and the Internet. This solution provides good quality and backward compatibility with minimum transmission and system overhead. Based on a calibrated colorimetric RGB color space well suited to cathode ray tube (CRT) displays, flat panel displays, television, scanners, digital cameras, and printing systems, the sRGB color space can be supported with minimum cost to software and hardware vendors. The four major technical components of the sRGB color space are the standard CRT primaries (HDTV P22 phosphors); the simple gamma value of 2.2, a D65 white point, and its well-defined viewing conditions.

Palettes and Color Selection

The PCL 5 language allows the user to define a palette of colors. Each color is specified by three quantities or values which are interpreted depending on the color space. For example, the color white in an RGB palette is (1, 1, 1) while this set of values in a CMY palette defines the color black. Each color in the palette is accessed using an index number, starting with 0 as the first color in the palette. The largest palette holds 256 colors, which is approximately the largest set of distinct colors the human eye can distinguish under normal viewing conditions.

A color from a palette can be applied to either text or vector graphics using the Foreground Color command. Once the command is invoked the selected color will be applied to all text and vector graphics page marking primitives, and to a certain extent to raster images.

Palettes can be identified with a Palette ID and then stored and recalled as needed. A palette stack mechanism is also supported for the convenience of applications that work well with a graphics stack.

PCL 5 Color Graphics Context

The Palette acts as the focal point of the PCL 5 color graphics context. The color space, render algorithm, color treatment, and pixel encoding mode are stored along with the palette. Therefore, selecting or restoring a palette also restores these values.

PCL 5 Color Mode

The PCL language has four modes or ways of specifying and using color:

- Black-and-White (monochrome) mode is the default mode so that backward compatibility with previous printers is maintained. When the printer is turned on it has a 2-entry palette containing the color white at index 0 and black at index 1. When the printer is reset with an E_{cE} it reverts to this mode.
- Simple Color mode is entered with the Simple Color command, which creates one of three fixed color palettes:
 - A monochrome, two-entry palette with white at index 0 and black at index 1.

- An RGB, eight-entry palette with the following colors starting at index 0: black, red, green, yellow, blue, magenta, cyan, and white.
- A CMY, eight-entry palette with the following colors starting at index 0: white, cyan, magenta, blue, yellow, green, red and black.
- PCL Imaging mode is entered with the Configure Image Data command that creates a programmable palette of a programmed size. This palette can be programmed using the color component and set index commands.
- HP-GL/2 Imaging mode is entered when HP GL/2 mode is entered and the initialize command IN creates a programmable palette that is shared between PCL and HP-GL/2.

Any and all of the modes can be used on a page. For example, you could enter the Simple Color mode to print a headline and bar chart, PCL imaging mode to print a photographic image, and Black-and-White mode for the text on the page. Each mode is described in more detail in Chapter 2. “Using Color Modes.”

PCL 5 Raster Images

Monochrome PCL 5 raster images are made up of a series of zeros and ones. A one indicates that a black dot should be deposited, a zero indicates no dot, letting the white background show through. A one-inch wide image with a resolution of 600 dots per inch (DPI) has 600 consecutive zeros and/or ones, which represent a horizontal slice through the image starting at the left edge of the image. This slice is known as a raster row. For an image one inch high and one inch wide, at 600 dpi there are 600 hundred rows of 600 zeros and/or ones. Color raster images follow the same conventions with this major exception: the representation of a dot is changed from a single zero or one to a color specification (a pixel).

Pixels and Pixel Encoding

Raster images can be thought of as being composed of a series of pixels (picture elements). In the case of monochrome raster images, a pixel is a single bit which takes on a value of zero or one. In color images a pixel is essentially a color specification. However, there are several ways of specifying a color, and how the color is specified is called the Pixel Encoding Mode (PEM).

The PCL 5 color command set supports several Pixel Encoding Modes. The PEMs are categorized first by whether the pixel is an index into a palette, or a color specification. The other PEM categorization is whether the pixel data is divided into planes and transferred one plane at a time or is transferred in sequential order. There are four supported Pixel Encoding modes:

- 1 Indexed by Plane
- 2 Indexed by Pixel
- 3 Direct by Plane
- 4 Direct by Pixel (also known as 24-bit direct).

For example, the format known as direct by plane, uses a 3-bit pixel where the first bit indicates the presence or absence of a red dot, the second a green dot and the third a blue dot. The data is still arranged in rows, but all the red data is sent, then the green and finally all the blue. The example below represents the commands to transfer an image with the direct by plane PEM. The underlined bits, while transferred separately, are logically from the same pixel.

```

EC*b#V row 1 plane 1 (red) b1 b1 b1 b1 b1 b1...
EC*b#V plane 2 (green) b2 b2 b2 b2 b2 b2...
EC*b#W plane 3 (blue) b3 b3 b3 b3 b3 b3...
EC*b#V row 2 plane 1 (red) b1 b1 b1 b1 b1 b1...

```

The direct by pixel PEM uses only the row transfer command. Each pixel is composed of three bytes, one byte per component of the color specification. All the bytes of a given pixel are transferred before the next one is transferred.

```

EC*b#W row x b1 b2 b3 b1 b2 b3 b1...

```

The *indexed by pixel* PEM is similar to the direct pixel PEM but the pixel occupies at most one byte and is an index into the current palette.

The *indexed by plane* PEM is similar to the direct by plane PEM except the pixel's value is an index into the current palette. The use of this mode is discouraged due to the extra processing required to combine the bits from each plane into a single number, which is then used as an index into the current palette.

Well-Behaved Raster

PCL raster images are processed most efficiently when the height and width of the image are specified before the Raster Start command begins an image data transfer. Furthermore, the entire image should be transferred before using the End Raster command to end the image. If the image is broken into pieces, certain print artifacts such as lines or squares can appear in the image. These can occur when “nearest neighbor operations” are applied to pixels that appear to be at the edge of an image, but are really inside an image that has been artificially broken up into smaller images.

2 Using Color Modes

Introduction

The PCL printer language has four color modes:

- Black-and-White
- Simple Color
- PCL Imaging
- HP-GL/2 Imaging

PCL allows you to use any mode or combination of modes to accomplish your printing objectives most efficiently.

All four of the color modes create a palette. The palette for each mode is discussed in the section describing that mode, and also in Chapter 3 (“Using Palettes”).

Black-and-White Mode (Default)

Black-and-White Mode is the default color mode. PCL devices power up in this mode and revert back to it whenever the printer receives an E_cE reset. Black-and-White mode is also selectable using the Simple Color command ($E_c*r#U$). This mode creates an unmodifiable, default 2-pen palette, with white at index 0 and black at index 1 (compatible with existing monochrome PCL 5 printers).

Simple Color Mode

Simple Color Mode, entered by the Simple Color command ($E_c*r#U$), creates a fixed-size, fixed-color, unmodifiable palette. Depending on the value field, $E_c*r#U$ can create a 2-pen Black-and-White palette, an 8-pen RGB palette, or an 8-pen CMY palette. When using the Simple Color mode, the pixel encoding mode is always indexed planar.

PCL Imaging Mode

PCL Imaging Mode, enabled by the Configure Image Data command ($E_c*v#W$), allows a maximum of 24 bits per pixel for color specification. Therefore, more colors may be specified than are obtainable in Simple Color Mode. In the PCL Imaging Mode, pixel encoding mode, bits per pixel, bits per primary, and the color palette are all programmable.

HP-GL/2 Imaging Mode

In HP-GL/2, the Initialize (IN) command starts color imaging and performs the following:

- Sets the pixel encoding mode to index by plane.
- Sets bits per index to 3.
- Creates an 8-pen palette that is reprogrammable in either PCL or HP-GL/2 contexts (see Chapter 3, “Using Palettes,” for more information).

Although default HP-GL/2 palettes are different than default PCL palettes, an HP-GL/2 palette is modifiable in either PCL or HP-GL/2 (using the Assign Color Index [$E_c*v#I$] or Pen Color [PC] commands, respectively). Likewise, a PCL palette created by the Configure Image Data command ($E_c*v#W$) is modifiable in both PCL and HP-GL/2 using the same commands.

The active palette is always transferred between HP-GL/2 and PCL contexts. Since only one palette at a time can be active, a new palette created in either context overwrites the current palette.

Simple Color Mode

The Simple Color command ($E_C^*r\#U$) specifies color selection from a fixed palette. RGB or CMY raster data must be sent by plane ($E_C^*b\#V$) as well as by row ($E_C^*b\#W$). The last plane in each row is sent using the $E_C^*b\#W$ command; all other planes are sent using the $E_C^*b\#V$ command. In Simple Color mode, the pixel encoding mode is always indexed planar.

Simple Color Command

The Simple Color command creates a fixed-size palette, whose color specification cannot be modified.

$E_C^*r\#U$

- #** = -3 - 3 planes, device CMY palette
- 1 - Single plane K (Black) palette
- 3 - 3 planes, device RGB palette

Default = 1

Range = -3, 1, 3

This command destroys the active palette and creates a new palette, which becomes the active palette. When the Simple Color mode is active, PCL and HP-GL/2 commands that modify the palette are locked out (NP, PC, $E_C^*v\#A$, $E_C^*v\#B$, $E_C^*v\#C$, $E_C^*v\#I$). When a Simple Color palette is popped from the stack ($E_C^*p\#P$), it cannot be modified, and the pixel encoding mode reverts to indexed planar.

- A value field of **1** creates a 2-entry Black-and-White default palette.
- A value field of **3** creates an 8-entry Device RGB palette (compatible with a PCL Imaging Mode palette, but not an HP-GL/2 default (IN) palette).
- A value field of **-3** creates an 8-entry palette in Device CMY color space.

The Simple Color palettes are structured as follows:

Single Plane (value = 1)

Index	Color
0	White
1	Black

3-Plane RGB (value = 3)

Index	Color
0	Black
1	Red
2	Green
3	Yellow
4	Blue
5	Magenta
6	Cyan
7	White

3-Plane CMY (value = -3)

Index	Color
0	White
1	Cyan
2	Magenta
3	Blue
4	Yellow
5	Green
6	Red
7	Black

PCL Imaging Mode

The PCL Imaging mode, entered using the Configure Image Data (CID) command ($E_C*v\#W$), creates a variable-sized programmable palette. It provides multiple color spaces, pixel encoding modes, and reprogrammable palettes.

Configure Image Data (CID) Command

The CID command provides configuration information for creating palettes and transmitting raster data. The CID command performs the following:

- Designates the color space for the newly created palette
- Designates the size of the palette
- Designates the Pixel Encoding Mode, the format of the raster data
- Designates, in certain circumstances, the size, in bits, of the three components of the color specifications. However, this information is rarely useful since it applies only to the direct-by-pixel PEM, where the format must be eight bits per component for 24-bit direct color, and the direct-by-plane, where there is one bit per component.

E_C*v6W **b0 b1 b2 b3 b4 b5**

Where:

6	=	The number of bytes following the “W”
b0	=	byte 0 The color space
b1	=	byte 1 The Pixel Encoding Mode
b2	=	byte 2 The number of bits per index which implies the size of the palette
b3	=	byte 3 The number of bits in color component (primary) #1
b4	=	byte 4 The number of bits in color component (primary) #2
b5	=	byte 5 The number of bits in color component (primary) #3

The bytes are ordered as follows and are unsigned bytes:

Byte	15 (MSB)	8	7	0 (LSB)	Byte
0	Color space		Pixel encoding mode		1
2	Bits/index		Bits/primary #1		3
4	Bits/primary #2		Bits/primary #3		5

Invalid configurations of the CID command are ignored and the data discarded. A minus or a plus sign in the value field (-6 or 6) is ignored

The data fields in the command, bytes zero to five, must contain byte-aligned binary data, not ASCII data.

Byte 0 (Color Space)

This byte specifies the color space. The range of values is 0 through 2. All other values are ignored.

Byte Value	Color Space
0	Device Dependent RGB (default)
1	Device Dependent CMY
2	Standard RGB (sRGB)

Color space 2, sRGB, was the designation for Colorimetric RGB in the Color LaserJet and Color LaserJet 5 printers. The value 2 is used to represent sRGB since it is analogous to a standardized Colorimetric RGB and the intent of the two color spaces is the same.

Byte 1 (Pixel Encoding Mode)

This byte designates the format of any subsequent raster images. The range of the value is zero to three. All other values for this field are ignored.

Value	Pixel Encoding Mode	Restrictions
0	Indexed by Plane	Bits/Index can only be 1, 2, 3, 4, 5, 6, 7, or 8. Bit/Components 1, 2, and 3 are ignored
1	Indexed by Pixel	Bits/Index can only be 1, 2, 4, or 8. Bit/Components 1, 2, and 3 are ignored
2	Direct by Plane	Bits/Components 1, 2, and 3 must be 1
3	Direct by Pixel	Bits/Components 1, 2, and 3 must be 8

The number of bits per index determines the size of the palette created by this command. In the case of the Indexed by Plane mode the number of planes needed to represent the index is also determined by the number of bits per index. Therefore, if a 256 entry palette is needed, then the bits per index is set to eight since $2^8 = 256$. If the Indexed by Plane mode is chosen, at most eight planes are needed to represent each row of data.

The recommended pixel encoding mode is Direct by Pixel, since this gives the most efficient raster processing. However, using this mode means that delta row compression should be used since it exploits redundancy between rows. Other PCL compression modes exploit redundancy within a row. With Direct by Pixel the redundancy from pixel to pixel in a row is masked by the differences at the byte level within the pixel, that is, the differences between the red, green, and blue bytes within the pixel.

Note

Raster data in Index by Plane or Direct by Plane modes cannot be compressed using raster compression mode 5.

You need one plane or one bit/pixel for each power of two colors in the palette. For example, a 256-color palette requires 8 planes or 8 bits/pixel ($2^8 = 256$).

PEM 0: INDEXED BY PLANE

In Pixel Encoding Mode 0, successive planes of data are sent for each raster row. A plane contains one bit for each pixel in a row. A pixel is not fully defined until all the planes for that row have been received, which is signaled by a transfer raster row command. The planes in a row form index numbers into the current palette. For example, assuming three bits per index, the underlined column of bits in the figure below is the palette index for pixel three of the first row (i_1 is the least significant bit, i_3 is the most significant bit). Note that the Transfer Raster Data by Plane command ($E_C*b\#V$) is used for all planes except the last plane of each row, which is sent using the Transfer Raster Data by Row command ($E_C*b\#W$).

$E_C*b\#V$	row 1	plane 1	i_1	i_1	i_1	<u>i_1</u>	i_1	i_1
$E_C*b\#V$		plane 2	i_2	i_2	i_2	<u>i_2</u>	i_2	i_2
$E_C*b\#W$		plane 3	i_3	i_3	i_3	<u>i_3</u>	i_3	i_3
$E_C*b\#V$	row 2	plane 1	i_1	i_1	i_1	i_1	i_1	i_1

Example:

In the example below, the row transfer commands are shown in binary for clarity, even though the actual data would be byte-aligned binary data. The example is for an eight-pixel-wide image.

E_C*v6W 00 00 03 08 08 08	Binary data for CID represented in hex. This command sets the color space to RGB, the PEM to Indexed by Plane, the palette size to 8 (2^3). The last 3 bytes are ignored.
E_C*r1A	Start raster.
$E_C*b1V10110000$	Transfer plane 1 (the first bit for each pixel in the first row).
$E_C*b1V01110000$	Transfer plane 2 (the second bit for each pixel in the row).
$E_C*b1W10101000$	Transfer plane 3 (the third and final bit for each pixel in the row) and move to the next row. Note that the $E_C*b\#W$ command is used to send the last plane of each row.

PEM 1: INDEXED BY PIXEL

In this mode, each pixel in a row is fully specified before any bits are sent for the next pixel. The bits for each pixel form a palette index number. Assuming four bits per index, the underlined block below is the palette index for pixel two of row one (i1 is the least significant bit).

$E_C^*b\#W$ row 1 i4 i3 i2 i1 i4 i3 i2 i1 . . .

$E_C^*b\#W$ row 2 i4 i3 i2 i1 i4 i3 i2 i1 . . .

$E_C^*b\#W$ row 3 i4 i3 i2 i1 i4 i3 i2 i1 . . .

Example:

In the example below the data in the row transfer commands are shown as two-digit hexadecimal numbers for clarity, even though the actual data would be byte-aligned binary data. The example is for a two-pixel-wide image.

E_C^*v6W 00 01 04 08 08 08	Binary Data for the CID command represented in hexadecimal. This command sets the color space to RGB, the PEM to Indexed by Pixel, the palette size to 16 (2^4). The last three bytes are ignored.
E_C^*r1A	Start raster
E_C^*b1W45	The most significant nibble selects palette entry 4 for the first pixel. The second pixel is set to index 5. Move to next row.
E_C^*b1W6A	The first pixel is index 6, the second pixel is index 10. Move to the next row.
E_C^*b1W03	The first pixel is index 0, the second pixel is index 3.

MODE 2: DIRECT BY PLANE

In this mode, a pixel is composed of three, one-bit components. The data is transferred a plane at a time, one plane for each component. Therefore, each bit in a plane represents one component of a pixel. The underlined bits below show the components for a pixel.

$E_C^*b\#V$	row 1	plane 1 (red)	b1	b1	b1	<u>b1</u>	b1	b1
$E_C^*b\#V$		plane 2 (green)	b2	b2	b2	<u>b2</u>	b2	b2
$E_C^*b\#W$		plane 3 (blue)	b3	b3	b3	<u>b3</u>	b3	b3
$E_C^*b\#V$	row 2	plane 1 (red)	b1	b1	b1	b1	b1	b1

Example:

In the example below the data in the row transfer commands are shown in binary for clarity, even though the actual data would be byte-aligned binary data. The example is for an eight-pixel-wide image.

E_C^*v6W	00 02 01 01 01 01	Binary Data for the CID command represented in hexadecimal. This command sets the color space to RGB, the PEM to Direct by Plane. The palette size is ignored. The last three bytes are always one for this mode.
E_C^*r1A		Start raster
$E_C^*b1V10110000$		Transfer plane 1 (the first bit for each pixel in the first row). Each bit controls the red primary.
$E_C^*b1V01110000$		Transfer plane 2 (the second bit for each pixel in the row). Each bit controls the green primary.
$E_C^*b1W10101000$		Transfer plane 3 (the third and final bit for each pixel in the row) and move to the next row. Each bit controls the blue primary. Note that the $E_C^*b\#W$ command is used to send the last plane of each row.

MODE 3: DIRECT BY PIXEL

This mode specifies a pixel as three, eight-bit components, thus the name 24-bit direct color. Assuming the RGB color space with the mandatory eight bits per component, the underlined bytes below define the first pixel of row two.

$E_C^*b\#W$	row 1	r7–r0	g7–g0	b7–b0 . . .
$E_C^*b\#W$	row 2	<u>r7–r0</u>	<u>g7–g0</u>	<u>b7–b0</u> . . .
$E_C^*b\#W$	row 3	r7–r0	g7–g0	b7–b0 . . .

Example:

In the example below the data in the row transfer commands are shown as two-digit hexadecimal numbers for clarity, even though the actual data would be byte-aligned binary data. The example is for a one-pixel-wide image.

E_C^*v6W	00 03 00 08 08 08	Binary Data for CID command represented in hexadecimal. This command sets the color space to RGB, the PEM to Direct by Pixel. The palette size is ignored. The last three bytes must be 8.
E_C^*r1A		Start raster
E_C^*b3W	45 06 30	The three bytes specify a single pixel. The first sets 45 as the red component's value, the second sets the green value to 06, and the third sets the blue value to 30.

Byte 2 (Number of Bits per Index)

This command creates a palette regardless of the PEM chosen. This byte determines the size of the created palette. The palette size is two raised to the power of n (2^n), where n is the bits per index.

- In the Indexed-by-Plane PEM, where the raster data is interpreted as palette indices, this value determines the number of planes required per row.

- In the Indexed-by-Pixel PEM, where the raster data is interpreted as palette indices, this value determines how to interpret the byte-ordered row transfers. The following list shows how each byte is translated into indices:

Bits/Index	Indices/Byte
1	8
2	4
4	2
8	1

- In the Direct-by-Plane and Direct-by-Pixel PEMs, byte 2 does not apply to the raster format.

Bytes 3, 4, and 5 (No. of Bits for Components 1, 2, and 3)

These bytes are ignored for the Indexed by Plane and Indexed Direct PEMs. For the Direct by Plane PEM they must be set to one bit per component. For the Direct by Pixel PEM, they must be set to eight bits per component.

HP-GL/2 Imaging Mode

The HP-GL/2 Imaging Mode provides a way of using vector commands in printing documents. Although the default PCL and HP-GL/2 palettes are not the same, when transferring from PCL to HP-GL/2, active palette information does stay the same. You can switch between PCL and HP-GL/2 and use the same palette, and you can also modify palettes using either PCL or HP-GL/2.

Compared to monochrome printers, the HP Color LaserJet printer family, DeskJet 1200C and 1600C color printers have some commands that are new and/or modified for use with color printers. Chapter 7 describes the new or modified HP-GL/2 commands.

If you are not familiar with using HP-GL/2, see the *PCL 5 Printer Language Technical Reference Manual*. It provides a detailed explanation of using HP-GL/2.

3 Using Palettes

Introduction

A palette is a collection of color specifications selected using index numbers. The figure below illustrates a palette. Each palette entry associates an index number with three primary color components. For HP-GL/2 purposes only, a pen width is also associated with each palette entry.

Color Palette				HP-GL/2
	Primary 1	Primary 2	Primary 3	Pen Width
0				
1				
2				
3				
4				
5				
6				
7				
8				
9				
n				
(max. 255)		• • •		• • •

Bits per Primary

- Primary 1 = 8
- Primary 2 = 8
- Primary 3 = 8

In non-raster mode, the current palette contains all the available colors. In raster mode, indexed color selection uses the palette, but direct selection does not.

Default palettes are created by all the PCL color modes (Black and White, Simple Color, PCL Imaging, and HP-GL/2 Imaging). The active palette may be modified when in the PCL Imaging or HP-GL/2 imaging modes, but not when in the Simple Color or Black and White modes. When switching between PCL 5 and HP-GL/2 contexts, the active palette is automatically transferred.

Multiple palettes can exist in the system via the Palette ID and Palette Stack mechanism. However, only one palette at a time can be active. A palette created in the PCL context remains active and unchanged when switching to the HP-GL/2 context, and a palette created in the HP-GL/2 context remains active and unchanged when switching to the PCL context. Performing a reset or entering PJI overwrites the active palette with the default black and white palette.

Whenever a new palette is created, the currently or previously active palette is destroyed. A new palette is created by power-on and also by the following commands:

- PCL Reset (E_cE)
- Simple Color ($E_c^*r\#U$)
- Configure Image Data ($E_c^*v\#W$)
- HP-GL/2 Initialize (IN)

The active palette can be saved by pushing it onto the palette stack with the Push/Pop Palette command ($E_c^*p\#P$). Popping a palette from the stack destroys the active palette—the popped palette becomes the active palette.

Saving the Palette

The current palette is destroyed when a new palette is created. The Push/Pop Palette command ($E_C^*p\#P$) can save (push) the current palette and then restore (pop) it.

Push/Pop Palette Command

This command pushes or pops the palette from the palette stack.

$E_C^*p\#P$

= 0 - Push (save) palette
 1 - Pop (restore) palette

Default = 0

Range = 0, 1 (invalid values are ignored)

A value of 0 (E_C^*p0P) pushes a copy of the active palette onto the palette stack. When a palette is pushed, the active palette is not affected.

A value of 1 (E_C^*p1P) pops the most recently pushed palette and destroys the active palette; the popped palette becomes the active palette. As with any stack, the last item pushed is the first item popped.

Pushing a palette saves the following parameters:

- Color definitions for each palette entry
- Pen widths (for HP-GL/2 use)
- Color space specification
- Number of bits per index
- Pixel encoding mode
- Number of bits per primary
- Color treatment
- Render algorithm

Pushing a palette does not save the following parameters.

- Foreground color
- Color components: 1st, 2nd, and 3rd
- Finish mode
- Monochrome print mode

The palette stack depth is limited by printer memory. Attempts to push a palette with insufficient memory cause an out-of-memory error. Attempts to pop from an empty stack are ignored.

Macros can push and pop palettes. A palette that was popped in an *executed* macro remains in effect at the end of the macro (this is not true for “called” or “overlaid” macros).

The PCL reset command (E_cE) or an exit to PJL causes the printer to empty the palette stack and overwrite the active palette with a non-programmable black and white palette. The HP-GL/2 commands IN and DF have no effect on the palette stack, but they do destroy the active palette and replace it with the default HP-GL/2 palette.

Palette Management by ID

All palettes have a unique ID (identification number). The default black and white palette created on power-up or E_{cE} has an ID of 0.

Palette management by ID lets applications have multiple palettes. As shown below, multiple palettes can exist in two areas: the palette stack and the palette store. The stack holds palettes that are pushed; the store holds palettes having palette IDs.

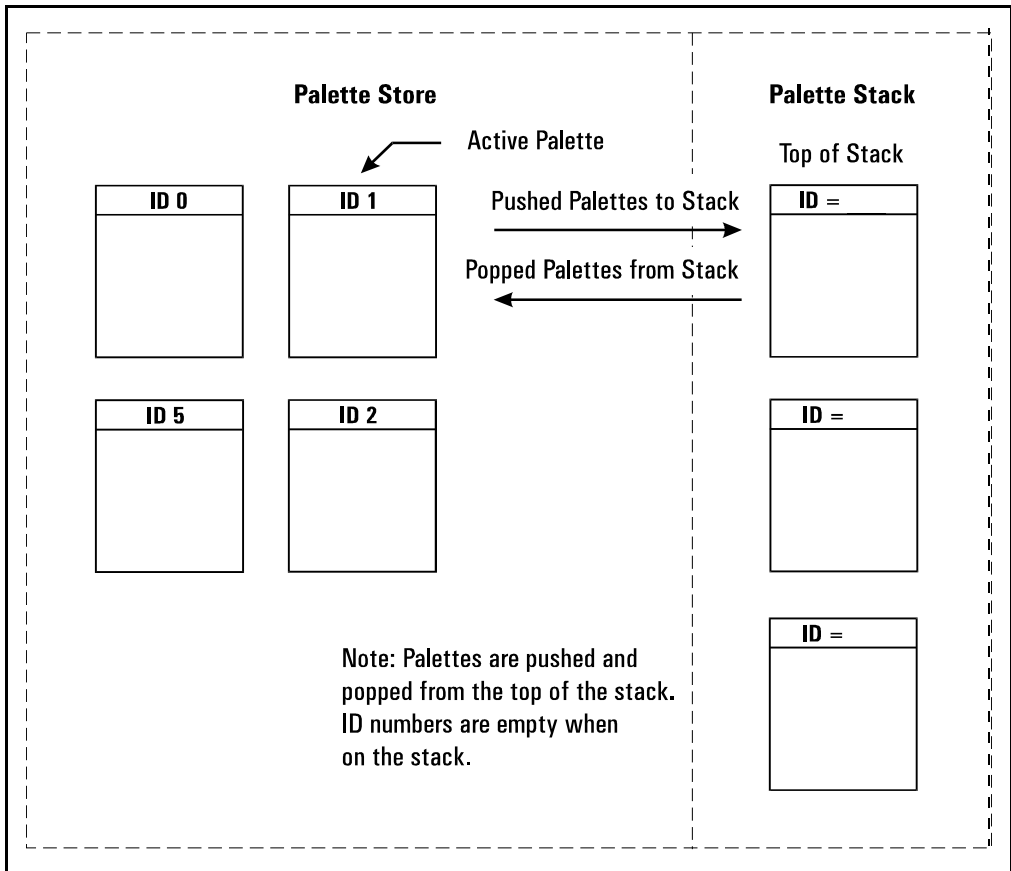

Palettes on the stack may not be selected by ID, since only a copy of a palette is pushed onto the stack; the original palette and ID remain in the palette store. A palette popped from the stack goes into the palette store, becomes the new active palette, and assumes the ID of the previously active palette, which is overwritten. Only one palette at a time may be active.

Management by ID allows applications to tag data, have multiple raster configurations, and have palettes for different color spaces—all without reconfiguring the active palette. For example, one palette can be created for PCL text, one for HP-GL/2 primitives, one for simple raster, and one for 24-bit raster. The application can then switch between palettes according to what is being sent to the printer.

Selecting a new active palette changes the PCL graphics state. Besides the color entries, a palette also has the graphics state which contains the color space, color treatment, and render algorithm. This ensures that the same color specification in a given palette will always produce the same printed color.

As described below, the Select Palette ($E_C\&p\#S$), Palette Control ($E_C\&p\#C$), and Palette Control ID ($E_C\&p\#I$) commands implement the three basic operations of management by ID.

- Selection of the active palette
- Deletion of palettes
- Copying of palettes

Select Palette Command

The Select Palette command selects a new active palette by specifying an ID number. The previously active palette is unchanged.

$E_C\&p\#S$

= Palette ID number

Default = 0

Range = 0 to 32767 (command is ignored for out- of-range values)

This command activates the designated palette in the palette store. The command is ignored if the specified ID matches the active palette's ID, or if no palette with that ID exists. The designated ID is saved as the palette select ID for the duration of the print job, or until another Select Palette command is received.

This command can be used to de-select the active palette and select as the new active palette a palette created by the Palette Control command ($E_C\&p\#C$). For example, to copy the active palette to an ID of 44 and select the new palette to use or modify, send $E_C\&p44i6c44S$.

When a palette creation command is received such as Configure Image Data ($E_C*v\#W$), Simple Color ($E_C*r\#U$), or an HP-GL/2 IN, the created palette overwrites the active palette and is assigned the current palette select ID.

A palette popped from the stack overwrites the active palette, and is assigned the current palette select ID.

$E_C E$ resets the palette select ID value to 0 and deletes all palettes in the palette stack and palette store, including the active palette, which is replaced by a default PCL fixed black and white palette with a palette ID of 0.

Macros affect the palette select ID value as follows:

- Calling or Overlaying a macro—saves the ID value and a copy of the active palette. Upon macro exit, the restored palette again becomes the active palette with the restored ID. An existing palette with this ID is deleted.
- Executing a macro—does not save the ID value or the active palette; changes remain in effect.

Palette Control ID

The Palette Control ID command specifies the ID number to be used by the Palette Control Command.

$\text{E}_c\&p\#I$

= Palette ID number

Default = 0

Range = 0 to 32767 (command is ignored for out-of-range values)

The ID number specified by this command is saved as the palette control ID and is used by the Palette Control command ($\text{E}_c\&p\#C$).

E_cE or power-up resets the palette control ID to 0, which is then the default black and white palette ID.

Macros affect the palette control ID value as follows:

- Calling a macro—saves the value and restores the value at exit.
- Executing a macro—does not save the value; changes remain in effect at exit.
- Overlaying a macro—copies the value before resetting to 0, and restores at exit.

Palette Control

The Palette Control command provides a mechanism for making and deleting palettes.

$E_C \& p \# C$

- # = 0 - Delete all palettes except those in the stack (active palette deleted)
- 1 - Delete all palettes in the stack (active palette is not affected)
- 2 - Delete palette (specified by Palette Control ID)
- 6 - Copy active palette to ID specified by Palette Control ID

Default = 0

Range = 0, 1, 2, 6 (command is ignored for unsupported values)

- A value of **0** deletes all palettes except those on the palette stack. The active palette is replaced by the default black and white palette (ID 0). The palette control ID is not used.
- A value of **1** clears the palette stack. The active palette is unaffected, and the palette control ID is not used.
- A value of **2** deletes the palette with the specified palette control ID if it exists; otherwise the command is ignored. For example, to delete palette 53, send $E_C \& p 53 i 2 C$. If the active palette's ID is specified the active palette is replaced by the default black and white palette. This option does not change the palette control ID value.

Note

When the active palette is replaced by the default black and white palette, the graphics state associated with the previous palette is also replaced.

- A value of 6 creates a copy of the active palette. The copy receives the ID specified by the last Palette Control ID command. For example, to copy the active palette to a palette with an ID of 14, send $E_C \& p 14 i 6 C$. The copied palette overwrites any palette that already has an ID equal to the palette control ID. The copied palette does not become the active palette. The command is ignored if a palette is to be copied to its own ID.

The Palette Control command provides a way of managing system memory by deleting palettes in either the stack or store that are no longer in use.

Palette Control that is exercised during macros can have significant impact on palettes that exist within the system. Deleting all palettes, or those on the stack, or the current palette, or all those except on the stack can have adverse effects when the macro is exited. The adverse effect could be the deletion of the desired palette, and replacement with a black and white non-programmable palette.

Simple Color Palettes

The Simple Color command ($E_C^*r\#U$) provides a quick way to select colors from a fixed, non-programmable palette.

The Simple Color command overwrites the current palette with one of the fixed palettes below. When the Simple Color command is in effect, the PCL and HP-GL/2 commands that modify a palette entry (NP, PC, $E_C^*v\#A$, $E_C^*v\#B$, $E_C^*v\#C$, $E_C^*v\#I$, $E_C^*t\#I$) are locked out. A popped simple color palette cannot be modified and the pixel encoding mode reverts to “index by plane”. Only the IN or the CID ($E_C^*v\#W$) commands can create a modifiable palette.

As shown below, a value field of 1 (E_C^*r1U) creates a black and white palette. A value of 3 creates an 8-pen palette in Device RGB color space. A value of -3 creates an 8-pen palette in Device CMY color space. All of these Simple Color palettes are fixed and non-programmable.

Single Plane (value = 1)

Index	Color
0	White
1	Black

3-Plane RGB (value = 3)

Index	Color
0	Black
1	Red
2	Green
3	Yellow
4	Blue
5	Magenta
6	Cyan
7	White

3-Plane CMY (value = -3)

Index	Color
0	White
1	Cyan
2	Magenta
3	Blue
4	Yellow
5	Green
6	Red
7	Black

CID Color Palettes

The Configure Image Data command, explained in detail in Chapter 2, creates a palette based upon the parameters in its data field. CID-created palettes are programmable: any entry can be reassigned a different color using PCL commands ($E_C^*v\#A$, $E_C^*v\#B$, $E_C^*v\#C$, $E_C^*v\#I$) or HP-GL/2 commands (PC, NP). Default palettes vary by color space.

Device RGB and sRGB Palettes

Bits/Index = 1

Index	Color
0	White
1	Black

Bits/Index = 2

Index	Color
0	Black
1	Red
2	Green
3	White

Bits/Index = 3 through 8

Index	Color
0	Black
1	Red
2	Green
3	Yellow
4	Blue
5	Magenta
6	Cyan
7	White
$n > 7$	Black

Device CMY Palettes

Bits/Index = 1

Index	Color
0	White
1	Black

Bits/Index = 2

Index	Color
0	White
1	Cyan
2	Magenta
3	Black

Bits/Index = 3 through 8

Index	Color
0	White
1	Cyan
2	Magenta
3	Blue
4	Yellow
5	Green
6	Red
7	Black
n > 7	Black

HP-GL/2 Palettes

Regardless of the color space, a default PCL palette is always different than a default HP-GL/2 palette. The following table shows the default palettes established in HP-GL/2. Like a default CID palette, a default HP-GL/2 palette can be modified in either PCL or HP-GL/2 contexts using the following commands:

PCL

- Color Components 1, 2, and 3 ($E_C^*v\#A$, $E_C^*v\#B$, $E_C^*v\#C$)
- Assign Color Index ($E_C^*v\#I$)

HP-GL/2

- Number of Pens (NP)
- Pen Color Assignment (PC)

Note

The IN command always establishes the 8-pen palette.

Two Pens

Pen Number	Color
0	White
1	Black

Four Pens

Pen Number	Color
0	White
1	Black
2	Red
3	Green

Eight Pens

Pen Number	Color
0	White
1	Black
2	Red
3	Green
4	Yellow
5	Blue
6	Magenta
7	Cyan
$n > 7$	Black

Foreground Color

All PCL marking entities utilize “foreground” color, which is selected from the current palette using the Foreground Color command ($E_C^*v\#S$). Foreground color interacts with raster color depending on the print model commands in effect.

Foreground Color Command

The Foreground Color command sets the foreground color to the specified index of the current palette.

$E_C^*v\#S$

= Index number into current palette

Default = 0

Range = 0 to $2^{(\text{current palette size})} - 1$

Specified values that are out-of-range of the current palette are mapped into a new index as follows:

$\text{Index} = \text{Specified foreground index modulo palette size}$

For example, specifying a foreground color index of 10 when the current palette size is 8 maps to 10 modulo 8, which is equal to 2. If the current palette was created under HP-GL/2, the index is mapped according to the HP-GL/2 mapping function.

Foreground color affects the following PCL page marking primitives:

- Text characters (they change to the foreground color, including underlining)
- Solid or monochrome patterned rectangular area fills (rules)
- Monochrome patterns (except HP-GL/2)
- Raster images

The following are not affected:

- User-defined color patterns (format 1 download patterns)
- HP-GL/2 marking primitives (HP-GL/2 uses “selected pen”, but ignores foreground color)

Note

Foreground color interacts with color raster images. In the printer, all color raster is resolved into three binary raster planes of CMY. Foreground color is applied to these planes, modifying the color image. For no interaction, set foreground color to black when sending color raster images.

After a foreground color is selected, changing any of the following will not change foreground color until a new Foreground Color command ($E_c^*v\#S$) is issued:

- Active Palette
- Configure Image Data (CID) command
- Render Algorithm

Programming Color Palettes

Except for the default black and white palette or the Simple Color palettes ($E_C*r\#U$), palette entries can be modified. The three primary components of a color are specified and the resulting color is assigned to the palette entry indicated by $E_C*v\#I$.

In the explanation below, the term “component” refers to the color space primary colors. For example, if the current color space is sRGB, component 1 indicates R, component 2 indicates G, and component 3 indicates B.

Color Component One

This command specifies the first component of the palette entry designated by the Assign Color Index command ($E_C*v\#I$).

$E_C*v\#A$

= First Component

Default = 0

Range = -32767.0000 to 32767.0000 (up to 4 decimal places; command is ignored for invalid configurations)

The Assign Color Index command actually applies this value and then resets it to 0.

Color Component Two

This command specifies the second component of the palette entry designated by the Assign Color Index command.

$E_C*v\#B$

= Second Component

Default = 0

Range = -32767.0000 to 32767.0000 (up to 4 decimal places; command is ignored for invalid configurations)

The Assign Color Index command actually applies this value and then resets it to 0.

Color Component Three

This command specifies the third component of the palette entry designated by the Assign Color Index command.

$E_C*v\#C$

= Third Component

Default = 0

Range = -32767.0000 to 32767.0000 (up to 4 decimal places; command is ignored for invalid configurations)

The Assign Color Index command actually applies this value and then resets it to 0.

Assign Color Index

This command assigns the three current color components to the specified palette index number.

$E_C*v\#I$

= Index Number

Default = 0

Range = 0 to $2^n - 1$, where n is the number of bits per index (no assignment for out-of-range values)

This command resets the color components to 0 after assignment. If the specified index number is greater than the palette size, no index assignment is made, but the three color components are set to 0.

4 Modifying Output Color

Introduction

The previous chapters of this manual have been concerned with giving an overview of the color printing process, choosing color modes, and using palettes. This portion of the manual explains how color can be modified to produce a desired result, from using halftone render algorithms to change the way color is rendered, to selecting a color treatment and finish mode. The HP color printers can modify colors using the following means:

- *Halftone render algorithms* provide a way to modify images based on a dither cell concept. The algorithm chosen determines how specified colors are “rendered” as dots on the printed page.
- *The Monochrome Print Mode* command converts each color to its grayscale equivalent for faster, draft printing.
- The *Driver Configuration* command provides a way to select a color treatment.
- The *Finish Mode* command allows the user to specify the finish, matte or glossy, to be applied to the document.

All of these methods of modifying output color are explained in the following sections.

Halftone Render Algorithms

The HP color printers have the capability of applying different halftone render algorithms to achieve the desired output on the printed image. Render algorithms allow you to change the characteristics of the image by changing the way pixels are rendered. Each halftone render algorithm produces a different affect on the output, varying the texture and color appearance of the printed image.

To choose the type of rendering to be used, use the Render Algorithm command, described below.

Render Algorithm Command

The Render Algorithm command selects the algorithm to be used for rendering page marking entities on a given page.

`E_C*t#J`

- `# = 0` - Continuous tone detail (high lpi) (device best dither)
- `3` - Device best dither
- `15` - Continuous tone smooth (high lpi)
- `18` - Continuous tone basic (low lpi)

Default = 3

Range = 0, 3, 15, 18 (invalid values are ignored)

Device Best Dither

This dither pattern produces the best results for many images. Note, however, that the recommended dither pattern varies with the image, the intended use of the image, and the subjective judgements of the user.

Monochrome Printing

The *Monochrome Print Mode* command converts each color value to its grayscale equivalent. This improves throughput, costs less to print, and eliminates waste by providing a draft mode.

Monochrome Print Mode Command

The Monochrome Print Mode command designates whether to print using the current rendering mode or a fast gray-scale equivalent. Pages printed using the gray-scale equivalent do not use any color and therefore print faster and more economically.

$\text{E}_C\&\mathbf{b}\#M$

- # = 0 - Print in mixed render algorithm mode
- 1 - Print using gray-scale equivalent

Default = 0

Range = 0, 1 (command is ignored for invalid values)

This command must be sent prior to printable data, or it is ignored. The command must be sent at the start of a job, since few, if any, applications support a mixture of color and monochrome printing of color images within the same document.

Driver Configuration Command

This command specifies the color treatment applied to each color specification.

$E_C * o \# W [device_id \ function_index \ Arguments]$

= Specifies the number of bytes to follow (device ID function index arguments)

Default = N/A

Range = see description below

device_id

Value	Printer
6	Color LaserJet printer family
8	Color LaserJet 4500 printer

function_index

function_index	Description	Argument Range	
4	Select Color Treatment	3	Vivid Graphics
		6	Screen Match

The following paragraphs describe the *function_index* values and their arguments.

Select Treatment

This value specifies which color treatment mode to use for rendering the next job.

Vivid Graphics

This setting adds color saturation to the resulting image, and provides access to the full gamut of the printer (at the cost of color matching).

Screen Match

Due to the emergence of sRGB (standard Red Green Blue) as an international color data standard, there is no longer a need to provide color adjustments in the printer driver to account for alternate types of RGB data. sRGB is the native color space of monitors, the default color space of the World Wide Web, the default space of many digital cameras and scanners. This treatment indicates that the printer should be ready to accept sRGB data. This is the preferred mode of operation to provide a good appearance match between the monitor and the printed document

The table below lists the driver configuration commands for both color treatments:

Note

The device_id and function_index arguments after the E_C^*o3W (such as 643) should actually be entered as ASCII-coded decimal. For example, instead of 643 you would actually enter the ACK control code, followed by the EOT and ETX control codes.

Treatment	Command	
	LJ 4500	Other Color LaserJet Family printers
Vivid Graphics	$E_C^*o3W843$	$E_C^*o3W643$
Screen Match	$E_C^*o3W846$	$E_C^*o3W646$

Finish Mode Command

The Finish Mode command allows the user to specify the finish, matte or glossy, to be applied to the document. A normal page has a matte finish. Glossy finish can be requested to be applied to the page as it's printed. The finish is distinct from the type of media. Therefore, a matte finish can be requested for glossy media, and a glossy finish can be requested for plain or matte paper.

$\text{E}_C\&\mathbf{b}\#F$

- # = 0 - Matte finish
- 1 - Glossy finish

Default = 0

Range = 0, 1 (command is ignored for invalid values)

The finish mode must be set before the first page is marked and applies to all the pages in the document. Each document defaults to a matte finish.

5 The PCL Print Model

Introduction

The Print Model feature allows images and characters to be filled with color, with any of the printer's predefined shading or cross-hatch patterns, or with a user-defined pattern. Images include any raster graphic, such as one created with PCL raster graphics commands (as described in Chapter 6, *Raster Graphics*); a rectangular fill area (as described later in this chapter as *PCL Rectangular Area Fill Graphics*); or characters selected from any font.

Figure 5-1 illustrates the use of the print model. The following definitions are helpful in describing Print Model operation:

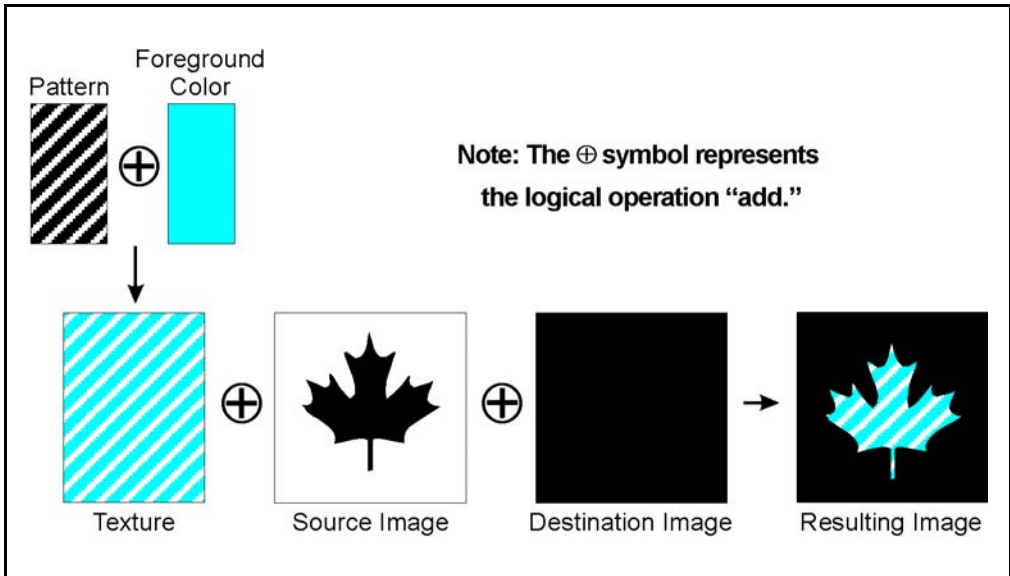

Figure 5-1 Print Model Imaging

- **Pattern**—The design which is “painted” through the non-white area of the source image onto the destination image. The pattern is defined by the Current Pattern ($E_C^*v\#T$) command. It may be a color pattern or a single-plane monochrome mask, such as the printer's internal predefined shading or cross-hatch patterns, or a user-defined pattern. Foreground color is not applied to a user-defined color pattern.

When printing a page, text and raster images are printed using the **current pattern**. Once the current pattern is specified, it stays in effect until another is selected or the printer is reset. A reset returns the current pattern to its default value (100% black). The current pattern does not always apply to rectangular area fill, which uses patterns defined by the rectangular area fill pattern commands.

- **Foreground Color**—Foreground color is selected from the current palette using the Foreground Color command ($E_C^*v\#S$). Foreground color affects everything except user-defined color patterns and HP-GL/2 primitives. Raster color mixes with foreground color (see Chapter 6 “Color Raster Graphics”).
- **Texture**—Texture is another name for the combination of pattern and foreground color, or for a color pattern which is not combined with a foreground color.
- **Source Image**—the Source Image is an image in which the non-white bits are replaced by the specified pattern. The source image functions like a stencil through which the pattern is applied to the destination image. The source image may be one of the following: HP-GL/2 primitives, rules, characters, or raster images (single plane mask or multi-plane color)
- **Destination Image**—The image onto which the source image/texture combination is placed. The destination image includes any images placed through previous operations.
- **Source Transparency Mode**—The transparency or opaqueness of the source image's “white” pixels as they are applied to the destination image (see the note below). Setting the source transparency mode to 1 (opaque) applies the source image's white pixels to the destination image; with a setting of 0 (transparent), these pixels have no effect on the destination.

- **Pattern Transparency Mode**—The transparency or opaqueness of the “white pixels” in the pattern (see the note below). When set to 0 (transparent), these pixels have no effect on the destination; when set to 1 (opaque), they are applied through the black pixels of the source pattern to the destination.
- **Logical Operations**—the Print Model uses logical operations, such as AND, OR, XOR, and NOT when determining which bits of the source, pattern, and texture become part of the resulting image. The Logical Operations command ($E_C^*I\#O$) can vary the logical operation used, thus varying the outcome.

Note

For RGB color images, “white” pixels are those for which all color primaries are 255. For CMY color images, “white” pixels are those for which all color primaries are 0.

For all rendering algorithms, white dots introduced in the dithering process are not subject to transparency modes.

Figure 5-2 illustrates the effects of the source and pattern transparency modes on the final image. (The transparency modes work a little differently with rectangular area fill—see “Pattern Transparency for Rectangular Area Fill” near the end of this chapter.)

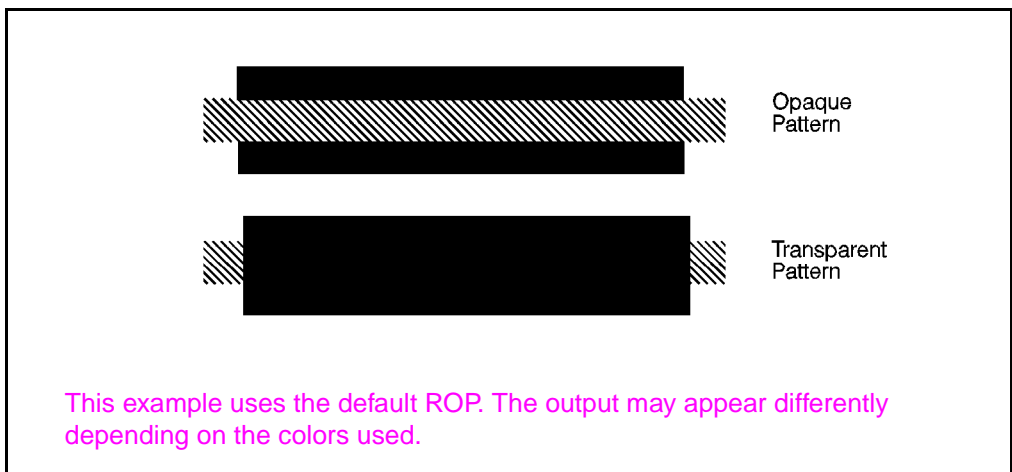

This example uses the default ROP. The output may appear differently depending on the colors used.

Figure 5-2 Opaque and Transparency Modes

Figure 5-3 demonstrates the transparency modes. In the first example (1a), the transparency mode for both the source image and the pattern is transparent. Since the source mode is “transparent,” only the non-white region (the circle) of the source image is overlaid on the destination. Since the pattern mode is also transparent, the patterned source image is applied only to the white areas of the destination.

In the second example (1b), the source mode is still “transparent,” but the pattern mode is “opaque” – so the pattern’s white pixels are applied to the destination. The resulting image shows the entire circle region visible and patterned.

In the third example (1c), the source mode is “opaque” and the pattern mode is transparent. Since the source mode is opaque, the entire source image (the circle and the surrounding square) appears overlaid onto the destination. The pattern, however, is allowed to pour through only onto the white-pixeled area of the destination. The circle is visible in the result, but only two opposing quarters appear patterned.

In the fourth example (1d), both source and pattern modes are “opaque.” The entire source image is overlaid onto the destination, and the entire circle is patterned.

1a:

Source Transparency Mode = 0 (Transparent)
Pattern Transparency Mode = 0 (Transparent)

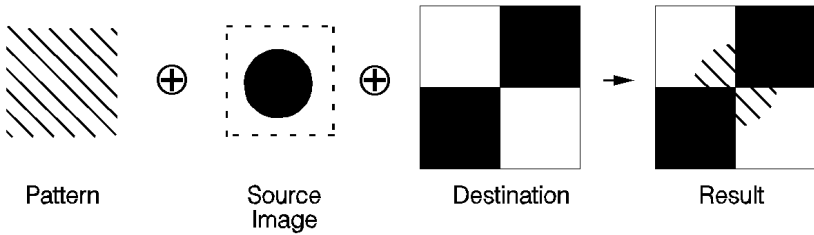

1b:

Source Transparency Mode = 0 (Transparent)
Pattern Transparency Mode = 1 (Opaque)

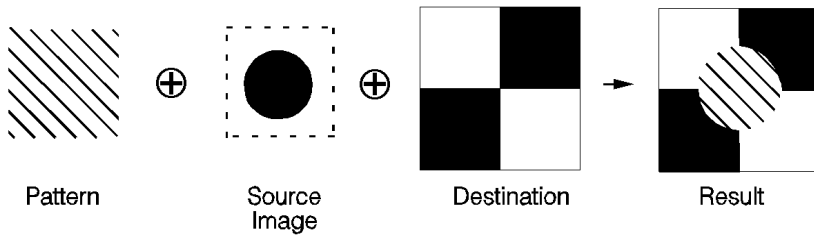

1c:

Source Transparency Mode = 1 (Opaque)
Pattern Transparency Mode = 0 (Transparent)

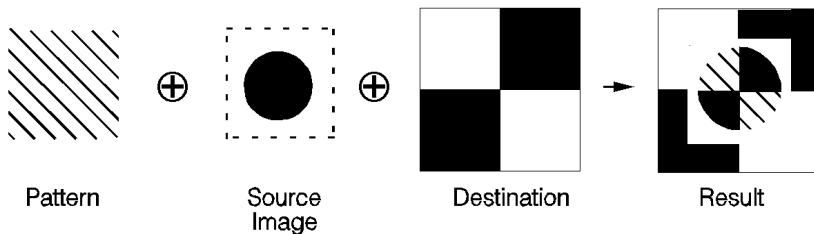

1d:

Source Transparency Mode = 1 (Opaque)
Pattern Transparency Mode = 1 (Opaque)

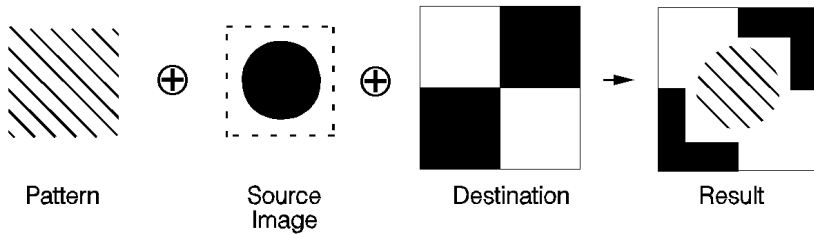

Note: The \oplus symbol represents the logical operation "add." In this example, the foreground color is black and the default ROP is used.

Figure 5-3 Effect of Transparency Modes on Images

Command Sequence

The table below shows the Print Model command sequence for selecting a current pattern and using it to fill a destination image. The commands for specifying transparency modes, logical operations, and patterns are discussed beginning on the following page. Foreground color is described in Chapter 3.

Operation	Comments
Download Page Data	Prior raster and character data downloaded to the page is considered destination image.
Select Transparency Modes	$E_C^*v\#N$ (source) and/or $E_C^*v\#O$ (pattern)
Specify the Logical Operation	If a logical operation other than the default (TSO-252) is desired, specify the operation with the $E_C^*l\#O$ command.
Select Specific Pattern ID	Pattern ID $E_C^*c\#G$
Download User-Defined Pattern	If using a user-defined pattern, it must be downloaded to the printer before using it.
Select Pattern	E_C^*v4T (selects downloaded pattern)
Specify the Foreground Color	For color printers, specify a Foreground Color ($E_C^*v\#S$) if desired. (This step is unnecessary if a color pattern is used.)
Download Source Image Data	Raster image/characters
Return to regular print mode	Default <i>current</i> pattern and transparency modes: E_C^*v0T (100% black pattern selected) and E_C^*v0N E_C^*v0O (transparency modes selected).
Download remaining page data	Transfer data for regular printing, or the above process may be repeated to produce another print model effect.
End of Page Data	

Source Transparency Mode Command

The Select Source Transparency Mode command sets the source image's transparency mode to transparent or opaque. This command determines whether the source's white pixels are applied to the destination.

$E_C * v \# N$

= 0 - Transparent
1 - Opaque

Default = 0

Range = 0, 1 (other values cause the command to be ignored)

With a transparency mode of "0" (transparent), the white regions of the source image are not copied onto the destination. With a transparency mode of "1" (opaque), the white pixels in the source are applied directly onto the destination. White pixels are unaffected by pattern or foreground color; they are either white or transparent.

Note

For RGB color images, "white" pixels are those for which all color primaries are 255. For CMY color images, "white" pixels are those for which all color primaries are 0.

White dots introduced in the dithering process are not subject to transparency modes.

Refer to the preceding definitions and the discussion of Figure 5-3 for an explanation of the effects of source transparency.

Pattern Transparency Mode Command

The Pattern Transparency Mode command sets the pattern's transparency mode to transparent or opaque.

$E_C * v \# O$

= 0 - Transparent
1 - Opaque

Default = 0

Range = 0, 1 (other values cause the command to be ignored)

A transparency mode of "0" (transparent) means that the white regions of the pattern image are not copied onto the destination. A transparency mode of "1" (opaque) means that the white pixels in the pattern are applied directly onto the destination.

Note

When printing white rules, the pattern transparency is treated as if it were "opaque"; white rules erase black rules regardless of the transparency mode.

For RGB color images, "white" pixels are those for which all color primaries are 255. For CMY color images, "white" pixels are those for which all color primaries are 0.

White dots introduced in the dithering process are not subject to transparency modes.

Refer to the preceding definitions and the discussion of Figure 5-2 and Figure 5-3 for an explanation of the effects of pattern transparency.

Logical Operations

The basic print model defines how a pattern, source image, and destination image are applied to each other using the print model's transparent and opaque modes to produce a resulting image. The Logical Operations ($E_C^*l\#O$) command specifies which logical operation is to be performed on the source, texture, and destination to produce a new destination. Transparency modes should be specified before the logical operation is performed or printable data is sent.

The print model process consists of the following steps:

- 1 Specify source and/or pattern transparency modes, if desired.
- 2 Specify the logical operation (or use the default).
- 3 Define the desired operands (source, destination, pattern).

Definitions

Source: The source image may be one of the following:

- HP-GL/2 primitives
- Rules
- Characters
- Raster images (single plane mask or multiplane color)

Destination: The destination image contains whatever is currently defined on the page. It includes any images placed through previous operations.

Pattern or Texture: The pattern is defined by the Select Current Pattern command ($E_C^*v\#T$). The terms pattern and texture are used interchangeably in this section.

Transparency Modes: The white pixels of the source and/or pattern may be made transparent (source transparency 0, pattern transparency 0). The destination shows through these areas. Transparency modes are set by the Source Transparency ($E_C^*v\#N$) and Pattern Transparency ($E_C^*v\#O$) commands.

The Print Model allows logical operations, such as AND, OR, XOR, NOT, to be performed on source, texture, and destination images. Transparency modes and Logical Operation must be specified before printable data is sent.

Operators

- Source Transparency (specified before logical operation; default is transparent)
- Pattern Transparency (specified before logical operation; default is transparent)
- Logical Operators (default is Texture OR Source)

Operands

- Source objects: character cell, raster image, rule, HP-GL/2 vectors and polygons
- Texture: foreground color + pattern mask, color pattern (format 1).
- Destination: current page definition

Operation

- IF (source transparent && source == white) RETURN destination
- IF (pattern transparent && pattern == white && source != white) RETURN destination
- ELSE RETURN (logical op (source, texture, destination))

Assuming three bits per pixel, the following diagram shows the process.

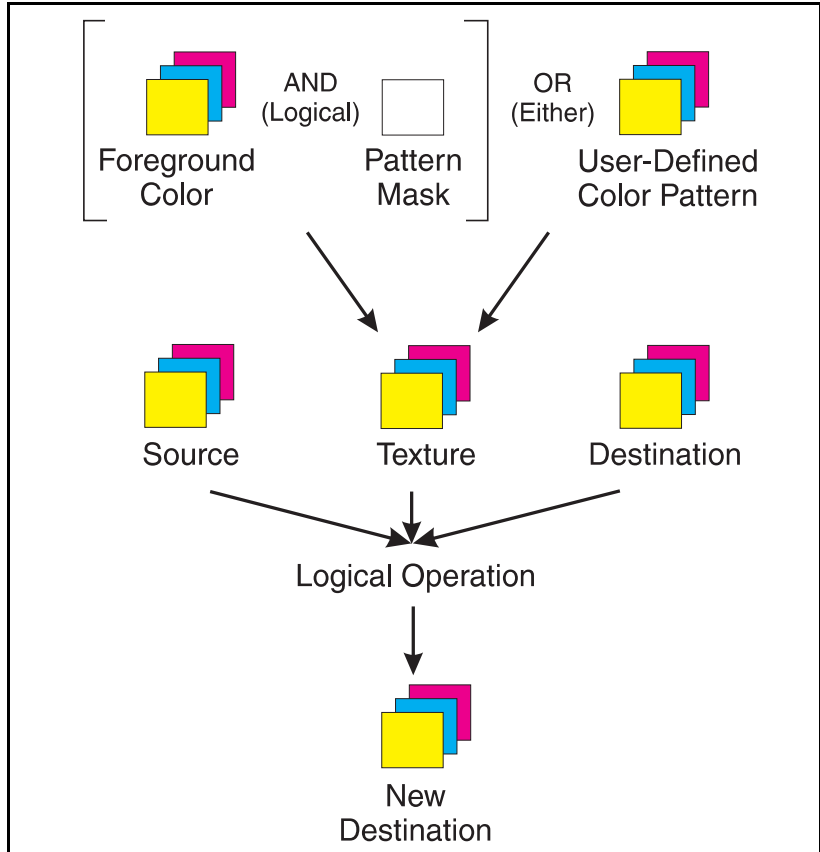

Figure 5-4 Logical Operations and the Print Model

Note

The Logical Operation command ($E_c * I \# O$) provides 255 possible logical operations. All of these logic operations map directly to their ROP3 (raster operation) counterparts (see the Microsoft Document, Reference, Volume 2, Chapter 11, Binary and Ternary Raster Operation Codes).

The logical operations were defined for Microsoft Windows for an RGB color space. In RGB space, a “1” is white and a “0” is black.

Logical Operations and Transparency Interactions

As described above, transparency modes operate in addition to logical operations. The Logical Operations (ROP3) in Table 5-4 are true only if source and pattern transparency (for white pixels) are explicitly set to opaque (E_C*v1N and E_C*v1O). If source and/or pattern transparency modes are transparent (defaulted), the additional operations shown below must be performed to achieve the final result.

The four basic interactions are:

- **Case 1:** Source and Pattern are opaque.
Texture = Color & Pattern.
RETURN ROP3 (Dest, Src, Texture).
- **Case 2:** Source is opaque, Pattern is transparent.
Texture = Color & Pattern.
Temporary_ROP3 = ROP3 (Dest, Src, Texture).
Image_A = Temporary_ROP3, & Not Src.
Image_B = Temporary_ROP3 & Pattern.
Image_C = Not Pattern & Src & Dest.
RETURN Image_A | Image_B | Image_C
- **Case 3:** Source is transparent, Pattern is opaque.
Texture = Color & Pattern.
Temporary_ROP3 = ROP3 (Dest, Src, Texture).
Image_A = Temporary_ROP3 & Src.
Image_B = Dest & Not Src.
RETURN Image_A | Image_B
- **Case 4:** Source and Pattern are transparent
Texture = Color & Pattern.
Temporary_ROP3 = ROP3 (Dest, Src, Texture).
Image_A = Temporary_ROP3 & Src & Pattern.
Image_B = Dest & Not Src.
Image_C = Dest & Not Pattern.
RETURN Image_A | Image_B | Image_C.

Note

The Transparency Mode is applied based on the color of each pixel. However, the Logical Operation is applied on a bit-by-bit basis without regard to color. In order to obtain a result consistent with the Logical Operation, the transparency modes should be set to Source Opaque and Pattern Opaque. In order to obtain a result consistent with the desired transparency mode, the Logical Operation should be set to 252 and the foreground color set to black.

Logical Operation Command

Specifies the logical operation (ROP) to be performed in RGB color space on destination, source and texture to produce new destination data. Texture is defined as a combination of pattern and foreground color.

$E_C * I \# O$

= Logical operation value (see Table 5-4)

Default = 252 (TSo)

Range = 0 to 255

The Logical Operation code, or Raster OPeration (ROP) code, is simply a systematic method of encoding all of the 256 possible ways that a Texture, Source, and Destination can be combined. Table 5-4 gives a table of ROPs from ROP 0 to ROP 255, where each operation is defined as a logic equation. This table can be difficult to understand and use. Furthermore, it does not show the differences that depend on the color space. A truth table is an alternative method for understanding the results of a logical operation. When used with ROPs for finding the resulting destination value, it is more easily understood than the logic operation.

ROP _{RGB} 252 (11111100) ¹			
(T)exture	(S)ource	(D)estination	(D)estination
1	1	1	1
1	1	0	1
1	0	1	1
1	0	0	1
0	1	1	1
0	1	0	1
0	0	1	0
0	0	0	0

¹ The first destination column is ignored and the second destination column is the result of the ROP (White = [1,1,1] and Black = [0,0,0]).

For example, the logic equation for ROP 252 in the RGB color space is $T \text{ OR } S$, which is shown as TSo in Table 5-4. The truth table for the ROP is shown above, and can be seen to correspond to the logic equation TSo , that is, D gets the value of $T \text{ OR } S$ without regard to the current value of D . Furthermore, the binary value of 252 is 11111100 and corresponds with the value of the D for all the combinations of T and S , when the truth table starts with (1, 1, 1) and ends with (0, 0, 0).

It's possible to derive the logical operation for a truth table and to create a truth table for a logical operation. However, the most important point is that the binary value of the ROPs number gives the Destination for all possible combinations of Texture, Source, and Destination.

The way the bits of the ROPs number map to the combinations of Texture, Source, and Destination depends on whether the color space is RGB or CMY. The least significant bit of the RGB ROP value maps to (0, 0, 0), the color black in RGB, and the most significant bit to (1, 1, 1), white in RGB. On the other hand, the CMY ROP reverses the mapping. This reversal hinges on the fact that RGB and CMY are the inverse of each other, i.e., RGB Black is (0, 0, 0) and CMY Black is (1, 1, 1), white. All other colors show the same relationship.

ROPs in the RGB Color Space

The RGB ROP truth tables shown in Table 5-1 illustrate how ROP 252 and ROP 90 work, and most importantly how the bits in the ROP map show destination values for each combination of Texture, Source and Destination. A "1" in the RGB color space represents white and a "0" black, which makes determining what shows on paper cumbersome for users since the paper is marked when the Destination has a "0" value.

Table 5-1. RGB ROP Truth Tables

ROP _{rgb} 252					ROP _{rgb} 90					ROP _{rgb} n				
(11111100)					(01011010)					n=(b ₇ b ₆ b ₅ b ₄ b ₃ b ₂ b ₁ b ₀)				
T	S	D	D		T	S	D	D		T	S	D	ROP _n	D
1	1	1	1	white	1	1	1	0	white	1	1	1	b ₇	b ₇
1	1	0	1		1	1	0	1		1	1	0	b ₆	b ₆
1	0	1	1		1	0	1	0		1	0	1	b ₅	b ₅
1	0	0	1		1	0	0	1		1	0	0	b ₄	b ₄
0	1	1	1		0	1	1	1		0	1	1	b ₃	b ₃
0	1	0	1		0	1	0	0		0	1	0	b ₂	b ₂
0	0	1	0		0	0	1	1		0	0	1	b ₁	b ₁
0	0	0	0	black	0	0	0	0	black	0	0	0	b ₀	b ₀

ROPs in the CMY Color Space

The CMY ROP truth tables in Table 5-2 shows examples of how the ROPs number determines the value of the Destination for all combinations of Texture, Source, and Destination. In the CMY color space a “0” is the absence of ink (white) and a “1” is the presence of ink (black), the opposite of the RGB color space value for black and white. Therefore, the ROPs results (Destination values) for the CMY color space are the opposite (negation) of the RGB values. However, a CMY ROP is easier to use when determining if the page is marked, since a “1” denotes marking.

Table 5-2. CMY ROP Truth Tables

ROP _{cmly} 252					ROP _{cmly} 90					ROP _{cmly} n				
(00000011)					(10100101)					n=(b ₇ b ₆ b ₅ b ₄ b ₃ b ₂ b ₁ b ₀)				
T	S	D	D		T	S	D	D		T	S	D	ROP _n	D
0	0	0	0	white	0	0	0	1	white	0	0	0	b ₇	!b ₇
0	0	1	0		0	0	1	0		0	0	1	b ₆	!b ₆
0	1	0	0		0	1	0	1		0	1	0	b ₅	!b ₅
0	1	1	0		0	1	1	0		0	1	1	b ₄	!b ₄
1	0	0	0		1	0	0	0		1	0	0	b ₃	!b ₃
1	0	1	0		1	0	1	1		0	1	1	b ₂	!b ₂
1	1	0	1		1	1	0	0		1	1	0	b ₁	!b ₁
1	1	1	1	black	1	1	1	1	black	1	1	1	b ₀	!b ₀

Using a ROP

The first step in using a ROP is to determine which color space you're in: RGB or CMY. Then determine the binary value of the ROP used. For example, suppose you want to use ROP 90 in the CMY color space. The binary equivalent of 90 is 01011010 when written in most significant to least significant bit order.

Looking at the truth table for ROP 90 in Table 5-2 you can see that the only time the page is marked is when the Texture and Destination are both "0" or both "1." However, the same result is given by negating each bit of the ROP number, 90, to give 10100101. Using the general table for CMY ROPs (the rightmost table in Table 5-2) you can plug the bit values from 90 into b₇ through b₀ to obtain the values in the truth table for ROP 90. Similarly, using ROP 90 in the RGB color space entails plugging 01011010 in the general table for RGB ROPs (the rightmost table in Table 5-1) to obtain the values in the truth table for ROP_{rgb} 90 (also in Table 5-1). This process works for any value from 0 to 255 and can be used to determine what will show for any given ROP, in either the RGB or CMY color spaces.

Note

Since PCL logical operations are interpreted in RGB space (white = 1, black = 0) rather than in CMY space (white = 0, black = 1), the results may not be intuitive. For example, ORing a white object with a black object in RGB space yields a white object. This is the same as ANDing the two objects in CMY space. It must be remembered that the printer operates in CMY space and inverts the bits. To convert from one color space to the other, write the ROP in binary format, invert the bits, and reverse the order.

When source and/or pattern transparency modes are set opaque (not defaulted), values specified by this command map directly to the ROP3 (raster operation) table values on the following page. However, when source and/or pattern transparency modes are set transparent, the additional operations shown on the previous page must be performed to achieve the final result.

Logical operations in the table are shown in RPN (reverse polish notation). For example, the value 225 corresponds to TDSoxn, the logical function of:

NOT (texture XOR (destination OR source))

Note

$\text{E}_{\text{C}}^* \ell \# \mathbf{O}$ is the PCL Version of the HP-GL/2 MC command.

This command sets the ROP value which affects not only PCL operation but also the HP-GL/2 ROP value.

EXAMPLE

The Logical Operation default value is 252 (TSO), corresponding to a logical function of:

(texture | source)

The result is computed below (source and pattern opaque).

Table 5-3. Logical Operation (ROP3)

	Bits							
	7	6	5	4	3	2	1	0
Texture	1	1	1	1	0	0	0	0
Source	1	1	0	0	1	1	0	0
Destination	1	0	1	0	1	0	1	0
ROP3 (source & pattern)	1	1	1	1	1	1	0	0
	(decimal 252)							

Each column of destination, source, and texture values are the input to the logical function. The result, 252, is the value that would be sent to identify the logical operation (refer to page 5-12 for source/pattern transparency interactions).

Table of Logical Operations

The Logical Operations (ROP3) table (Table 5-4) shows the mapping between input values and their logical operations. Note that the logical operations are specified as RPN (reverse polish notation) equations. Here is a key to describe what the Boolean Function values mean;

S = Source	a = AND
T = Texture	o = OR
D = Destination	n = NOT
	x = EXCLUSIVE OR

Note

Since logical operations are interpreted in RGB space (white = 1 and black = 0) rather than in CMY space (white = 0 and black = 1), the results may not be intuitive. For example, ORing a white object with a black object in RGB space yields a white object. This is the same as ANDing the two objects in CMY space. It must be remembered that the printer operates in something similar to a CMY space and inverts the bits and reverses the order.

Table 5-4. Logical Operations (ROP3)

Input Value	Boolean Function	Input Value	Boolean Function
0	0	27	SDTSxaxn
1	DTSoon	28	TSDTaox
2	DTSona	29	DSTDxaxn
3	TSon	30	TDSox
4	SDTona	31	TDSoan
5	DTon	32	DTSnaa
6	TDSxnon	33	SDTxon
7	TDSaon	34	DSna
8	SDTnaa	35	STDnaon
9	TDSxon	36	STxDSxa
10	DTna	37	TDSTanaxn
11	TSDnaon	38	SDTSoax
12	STna	39	SDTSxnox
13	TDSnaon	40	DTSxa
14	TDSonon	41	TSDTSoaxxn
15	Tn	42	DTSana
16	TDSona	43	SSTxTDxaxn
17	DSon	44	STDSoax
18	SDTxnon	45	TSDnox
19	SDTaon	46	TSDTxox
20	DTSxnon	47	TSDnoan
21	DTSaon	48	TSna
22	TSDTSanaxx	49	SDTnaon
23	SSTxDSxaxn	50	SDTSoox
24	STxTDxa	51	Sn
25	SDTSanaxn	52	STDSaox
26	TDSTaox	53	STDSxnox

Table 5-4. Logical Operations (ROP3) (continued)

Input Value	Boolean Function	Input Value	Boolean Function
54	SDTox	81	DSTnaon
55	SDToan	82	DTSDaox
56	TSDToax	83	STDSxaxn
57	STDnox	84	DTSonon
58	STDSxox	85	Dn
59	STDnoan	86	DTSox
60	TSx	87	DTSoan
61	STDSonox	88	TDSToax
62	STDSnaox	89	DTSnox
63	TSan	90	DTx
64	TSDnaa	91	DTSDonox
65	DTSxon	92	DTSDxox
66	SDxTDxa	93	DTSnoan
67	STDSanaxn	94	DTSDnaox
68	SDna	95	DTan
69	DTSnaon	96	TDSxa
70	DSTDaox	97	DSTDSaoxxn
71	TSDTxaxn	98	DSTDoax
72	SDTxa	99	SDTnox
73	TDSTDaooxn	100	SDTSoax
74	DTSDoax	101	DSTnox
75	TDSnox	102	DSx
76	SDTana	103	SDTsonox
77	SSTxDSxoxn	104	DSTDSonooxn
78	TDSTxox	105	TDSxxn
79	TDSnoan	106	DTSax
80	TDna	107	TSDTSoaoxn

Table 5-4. Logical Operations (ROP3) (continued)

Input Value	Boolean Function	Input Value	Boolean Function
108	SDTax	135	TDSaxn
109	TDSTDoaxxn	136	DSa
110	SDTSnoax	137	SDTSnaoxn
111	TDSxnan	138	DSTnoa
112	TDSana	139	DSTDxoxn
113	SSDxTDxaxn	140	SDTnoa
114	SDTSxox	141	SDTSxoxn
115	SDTnoan	142	SSDxTDxax
116	DSTDxox	143	TDSanan
117	DSTnoan	144	TDSxna
118	SDTSnaox	145	SDTSnoaxn
119	DSan	146	DTSDToaxx
120	TDSax	147	STDaxn
121	DSTDSoaxxn	148	TSDTSoaxx
122	DTSDnoax	149	DTSaxn
123	SDTxnan	150	DTSxx
124	STDSnoax	151	TSDTSonoxx
125	DTSxnan	152	SDTSonoxn
126	STxDSxo	153	DSxn
127	DTSaan	154	DTSnax
128	DTSaa	155	SDTSoaxn
129	STxDSxon	156	STDnax
130	DTSxna	157	DSTDoaxn
131	STDSnoaxn	158	DSTDSaoux
132	SDTxna	159	TDSxan
133	TDSTnoaxn	160	DTa
134	DSTDSoaxx	161	TDSTnaoxn

Table 5-4. Logical Operations (ROP3) (continued)

Input Value	Boolean Function	Input Value	Boolean Function
162	DTSnoa	189	SDxTDxn
163	DTSDxoxn	190	DTSxo
164	TDSTonoxn	191	DTSano
165	TDxn	192	TSa
166	DSTnax	193	STDSnaoxn
167	TDSToaxn	194	STDSonoxn
168	DTSoa	195	TSxn
169	DTSoxn	196	STDnoa
170	D	197	STDSxoxn
171	DTSono	198	SDTnax
172	STDSxax	199	TSDToaxn
173	DTSDaoxn	200	SDToa
174	DSTnao	201	STDoxn
175	DTno	202	DTSDxax
176	TDSnoa	203	STDSaoxn
177	TDSTxoxn	204	S
178	SSTxDSxox	205	SDTono
179	SDTanan	206	SDTnao
180	TSDnax	207	STno
181	DTSDoaxn	208	TSDnoa
182	DTSDTaoxx	209	TSDTxoxn
183	SDTxan	210	TDSnax
184	TSDTxax	211	STDSoaxn
185	DSTDaoxn	212	SSTxTDxax
186	DTSnao	213	DTSanan
187	DSno	214	TSDTSoaxx
188	STDSanax	215	DTSxan

Table 5-4. Logical Operations (ROP3) (continued)

Input Value	Boolean Function	Input Value	Boolean Function
216	TDSTxax	236	SDTao
217	SDTSaoxn	237	SDTxno
218	DTSDanax	238	DSO
219	STxDSxan	239	SDTnoo
220	STDnao	240	T
221	SDno	241	TDSono
222	SDTxo	242	TDSnao
223	SDTano	243	TSno
224	TDSOa	244	TSDnao
225	TDSOxn	245	TDno
226	DSTDxax	246	TDSxo
227	TSDTaoxn	247	TDSano
228	SDTSxax	248	TDSao
229	TDSTaoxn	249	TDSxno
230	SDTSanax	250	DTo
231	STxTDxan	251	DTSnoo
232	SSTxDSxax	252	TSo
233	DSTDSanaxxn	253	TSDnoo
234	DTSao	254	DTSoo
235	DTSxno	255	1

Pixel Placement

HP PCL 5 printers place pixels at the intersection of the squares of a theoretical, device-dependent grid covering the printable area on the page. Depending on the image and the logical operation in effect, a problem may occur when the sides of two polygons touch each other—the pixels along the common border may be printed twice or not at all. For example, a source rectangle consisting of all 1's that is XORed with a destination consisting of all 1's produces a white rectangle; but if another source rectangle is placed on the page touching the first rectangle, the two rectangles will be white-filled except at their common border ($(1 \wedge 1) \wedge 1 = 1$).

To correct situations where this problem occurs, the PCL printer language provides a choice of pixel placement models: grid intersection and grid centered. The grid intersection model is the default: pixels are rendered on the intersections of the device-dependent grid covering the page. In the grid-centered model, the number of rows and columns are each reduced by one, and pixels are placed in the center of the squares, rather than at the intersections.

The following example illustrates the concepts of the two models (see Figure 5-5). Assume a rectangle extends from coordinate position (1,1) to position (3,4). As shown below, for the same coordinates, the grid-centered model produces a rectangle that is one dot row thinner and one dot row shorter than the grid intersection model. Thus, the grid-centered model should be selected when two or more polygons on a page may share a common border.

Since PCL printers print only at the intersections of the grid, the actual implementation of the grid-centered model is shown on the right.

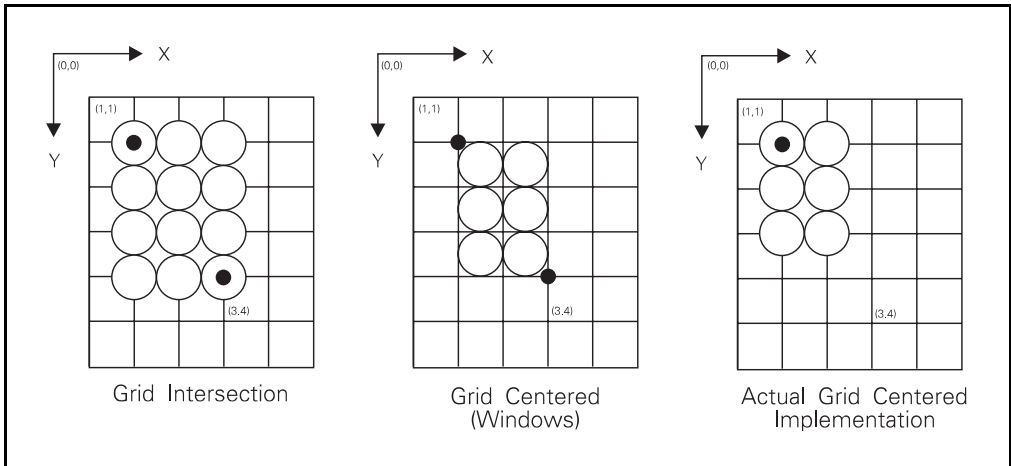

Figure 5-5 Pixel Placement

Note The grid-centered method is used by Microsoft Windows.

When rectangular area fills are used and grid intersection is used, an overlapping of pixels can occur if rectangular area fills are placed adjacent to one another (as shown below). Depending on the raster operation presently in effect, this overlap can produce undesirable results in the final printed image. To avoid this problem, use the grid-centered method.

Note

Since PCL printers print only at intersections, grid- centered pixel placement is implemented as shown on the right.

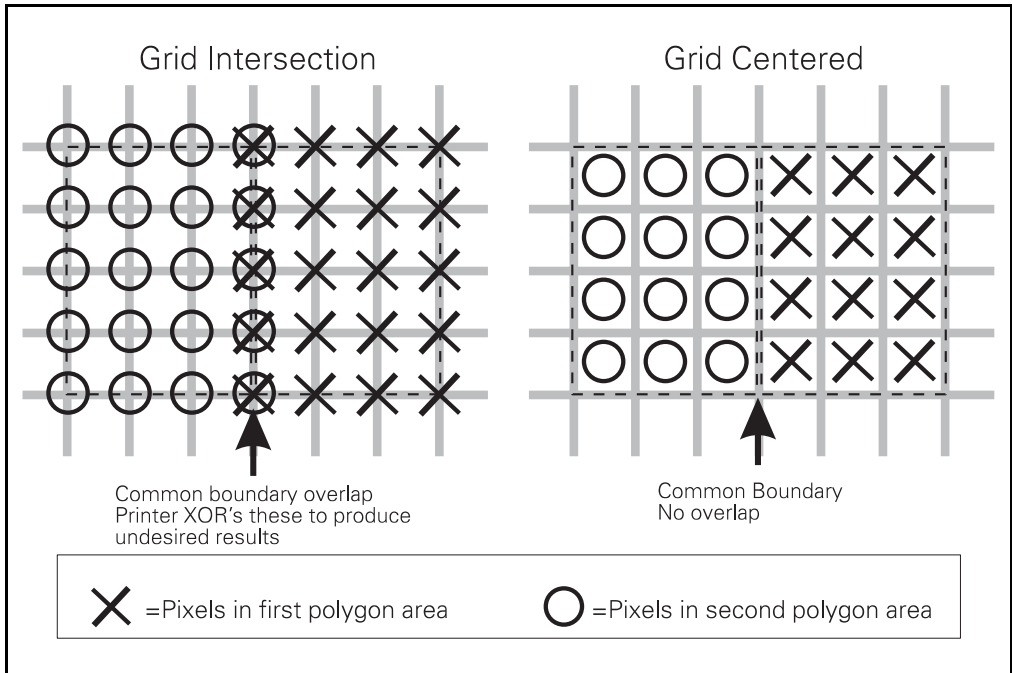

Figure 5-6 Pixel Placement Variations

There are two commands that modify the pixel placement function: the PCL Pixel Placement command ($E^c \ell \#R$) and the HP-GL/2 Pixel Placement command (PP).

Pixel Placement Command

Determines how pixels are rendered in images.

$E_C^*l \# R$

- # = 0 - Grid intersection
- 1 - Grid centered

Default = 0

Range = 0, 1 (command is ignored for other values)

Two models are used for rendering pixels when an image is placed on paper:

- Grid Intersection Model
- Grid Centered Model

This command can be used multiple times per page. It has no effect except to switch the model being used for imaging.

Note

The PCL Pixel Placement command determines how pixels are placed for both PCL and HP-GL/2 operation.

This command performs the same function as the HP-GL/2 PP command described in Chapter 7.

Filling with Patterns

The procedure for applying patterns to text, raster images, and rectangular areas is essentially the same, except that for text and raster images the Current Pattern ($E_C^*v\#T$) command is used, and for rectangular areas the Fill Rectangular Area ($E_C^*c\#P$) command is used. The procedures below describe how to fill with PCL and HP-GL/2 patterns.

Patterns for Text and Raster Images

Use the following general procedure to fill text and raster images with a non-solid pattern.

- 1 Specify the Pattern ID ($E_C^*c\#G$) command. For HP-defined patterns, select an ID that specifies the desired pattern.
- 2 Download the pattern ($E_C^*c\#W$). This step is for user-defined patterns only. The downloaded pattern adopts the current pattern ID.
- 3 Apply the pattern to all subsequent text and raster images. Specify the current pattern type ($E_C^*v\#T$).

Patterns for Rectangles

Use the following general procedure to apply a non-solid pattern to rectangular areas.

- 1 Specify the Pattern ID ($E_C^*c\#G$). For HP-defined patterns, select an ID that matches an HP-defined pattern.
- 2 Download the pattern ($E_C^*c\#W$). This step is for user-defined patterns only. The downloaded pattern adopts the current pattern ID.
- 3 Define the rectangle. Position the cursor and specify the rectangle size ($E_C^*c\#A$, $E_C^*c\#B$ or $E_C^*c\#H$, $E_C^*c\#V$).
- 4 Apply the pattern to the rectangle. Send the Fill Rectangular Area command ($E_C^*c\#P$).

HP-GL/2 Patterns

PCL patterns can be used in HP-GL/2 mode, but HP-GL/2 patterns cannot be used in PCL mode. Using HP-GL/2, patterns are downloaded using the RF (Raster Fill) command, and applied using the FT (Fill Type) or SV (Screened Vectors) commands.

Pattern ID (Area Fill ID) Command

The Pattern ID command (formerly called Area Fill ID) identifies the specific shading, cross-hatch, or user-defined pattern. (This command is also used for rectangular area fill, described later in this chapter.)

$E_C * c \# G$

Selecting Shaded patterns:

= 1 thru 2 = 1-2% shade
3 thru 10 = 3-10% shade
11 thru 20 = 11-20% shade
21 thru 35 = 21-35% shade
36 thru 55 = 36-55% shade
56 thru 80 = 56-80% shade
81 thru 99 = 81-99% shade
100 = 100% shade

Selecting Cross-Hatch patterns:

= 1 - Pattern #1
2 - Pattern #2
3 - Pattern #3
4 - Pattern #4
5 - Pattern #5
6 - Pattern #6

Selecting User-Defined patterns:¹

= ID number of user-defined pattern

¹ Not supported on all PCL 5 printers. Refer to the "PCL Feature Support Matrix" in Chapter 1 of the *PCL 5 Comparison Guide* for specifics.

Default = 0 (no pattern)

Range = 0 – 32767 (values outside the range are ignored)

For rectangular areas, the pattern "material" is determined by both the pattern ID and the value of the Fill Rectangular Area command. For other images, the pattern material is determined by the pattern ID and the value of the Select Pattern command.

Figure 5-7 and Figure 5-8 illustrate the HP-defined shading patterns and cross-hatched patterns, respectively.

Note

This command is used for both the Select Pattern and Rectangular Area Fill graphics.

For user-defined patterns, this command, sent prior to downloading a user-defined pattern, assigns an ID pattern number to the downloaded pattern. (For more information, see "User-Defined Pattern Graphics," later in this chapter.)

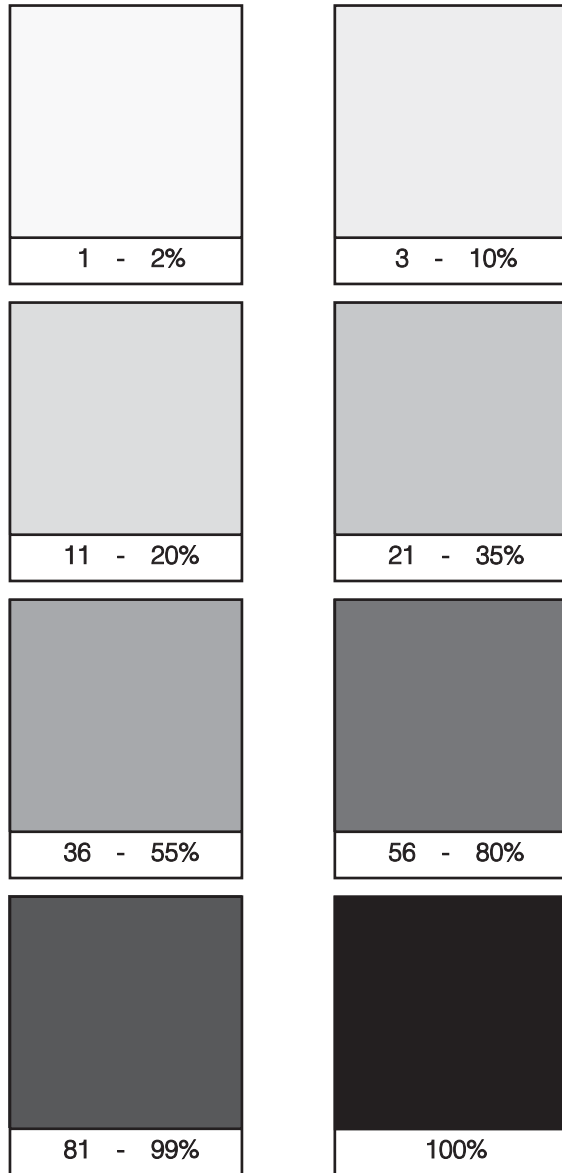

Figure 5-7 Shading Patterns

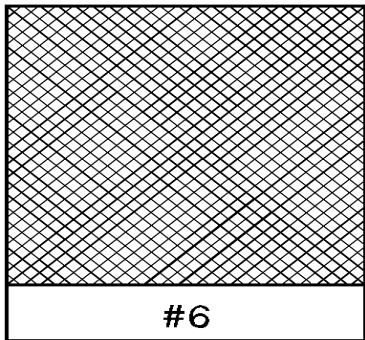
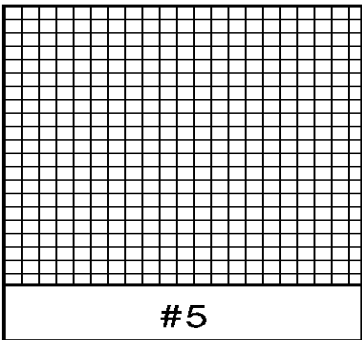
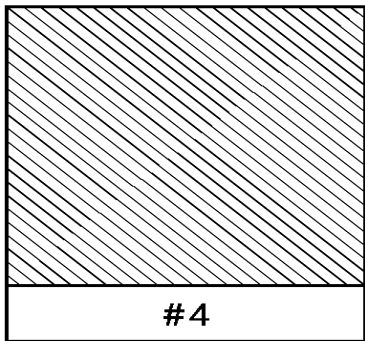
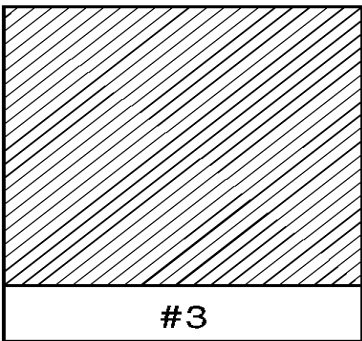
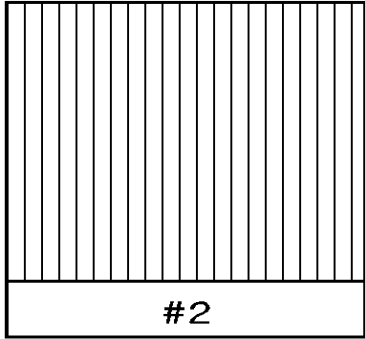
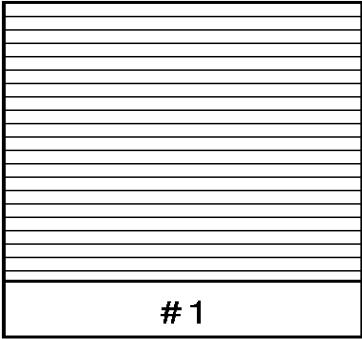

Figure 5-8 Cross-Hatch Patterns

Select Current Pattern Command

The Select Current Pattern command identifies the type of pattern to be applied onto the destination.

$E_C * v \# T$

- # = 0 - Solid black or foreground color
- 1 - Solid white
- 2 - Shading pattern
- 3 - Cross-hatch pattern
- 4 - User-defined pattern

Default = 0

Range = 0 - 4 (values outside of range are ignored)

This command selects which type of pattern is applied. For values 2, 3, and 4, the desired shading level, cross-hatch pattern, or user-defined pattern number is identified by the Pattern ID command described earlier in this chapter.

Note

For selecting or changing the current pattern, the Select Current Pattern ($E_C * v \# T$) and the Pattern ID ($E_C * c \# G$) commands work together. **Sending the current pattern** (Select Current Pattern command) **alone does not change the current pattern; the Pattern ID must be sent first.** However, when selecting solid white (white rule) or solid black (black rule), only the Select Current Pattern command is required.

Once a current pattern is selected, that pattern applies to all images placed on the page until a new pattern is selected.

User-Defined Pattern Graphics

In addition to the eight shading patterns and six cross-hatch patterns, users can design their own fill patterns. These **user-defined patterns** are downloaded to the printer and controlled using three commands:

- Download Pattern $E_c*c\#W$ [data]
- Set Pattern Reference Point $E_c*p\#R$
- Pattern Control $E_c*p\#Q$

Using User-Defined Patterns

To create a new pattern, a user defines a binary raster data image as a base pattern. This base pattern is downloaded to the printer using the User-Defined Pattern command. Prior to downloading the pattern, a Pattern ID command is sent to assign the user pattern an ID number. This ID number is used to select the pattern for printing and for pattern management.

To apply the pattern to an image, the printer duplicates or tiles (like placing ceramic tiles) the pattern across and down the page. This pattern can be applied to any image, including rectangular area fill.

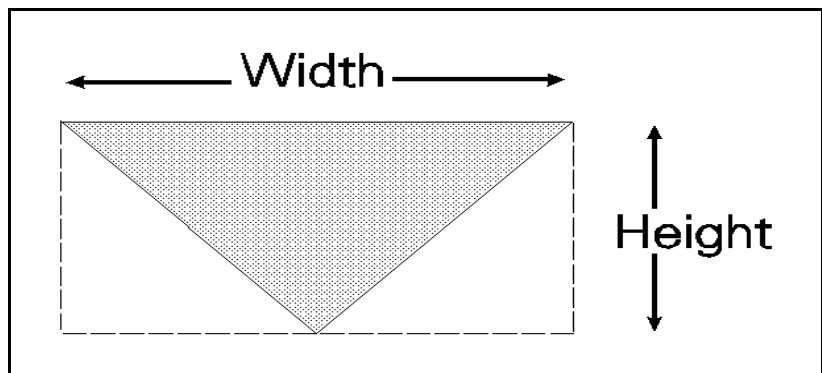

Figure 5-9 User-Defined Base Pattern Example

A user-defined pattern may be applied to any image in the same manner as the internal cross-hatch or shade patterns.

Note

For efficient memory usage and improved performance, it is strongly recommended that user-defined patterns should be 8x8, 16x16, or 32x32 in size. Specification of patterns that are either 1 pixel in height or width is strongly discouraged.

If user-defined halftones are also used, they need to be either the same size or multiples of each other to avoid render anomalies due to each pattern being rendered differently across the page (if tiled), or due to variations in xy position.

How the Printer Tiles a Pattern

A user-defined base pattern is a rectangular binary pattern stored in the printer. To apply the pattern to an image area on the page, the printer duplicates the base pattern across and down the page. This process is referred to as tiling. (The pattern is only applied to those areas on the page for which the pattern is required.)

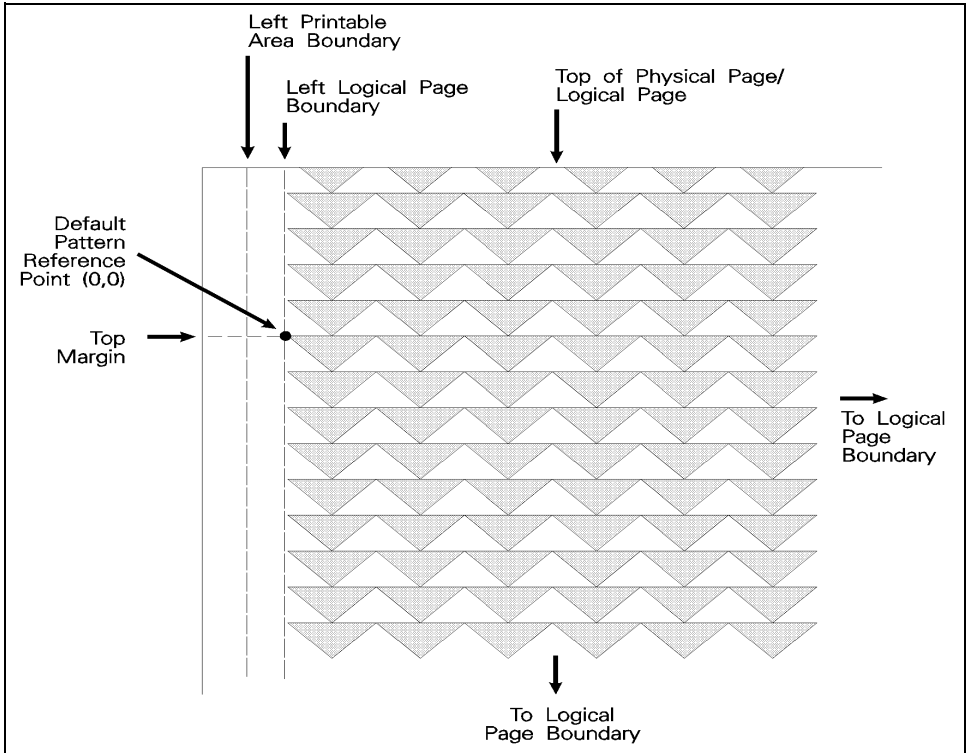

Figure 5-10 Pattern Layout Across the Printable Area

Pattern Reference Point

The pattern reference point is a position on the logical page at which the base pattern is positioned for tiling. The upper left corner of the base pattern is positioned at this point (see Figure 5-10). The default pattern reference point is position 0,0. However, it is possible to set the pattern reference point to the current cursor position. This allows the pattern to be positioned or adjusted for fill areas. The pattern reference point may be shifted more than once for as many fill areas as there are on a page (the area must be filled before the tile point is moved for the next fill area).

Figure 5-11 shows two areas filled with the pattern reference point fixed at the default (0,0) position. The lower portion of the illustration shows two areas in which the pattern reference point was moved to the upper left corner of each area and the area filled separately.

Pattern Reference Point at Default Position

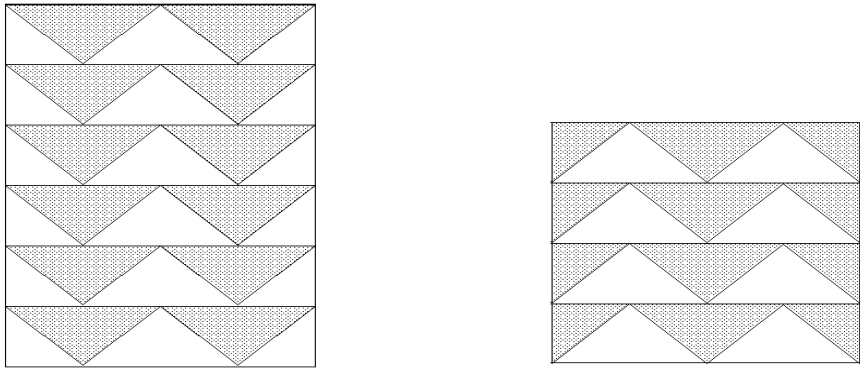

Pattern Reference Point Position at upper left corner of area before tiling (filling) each area

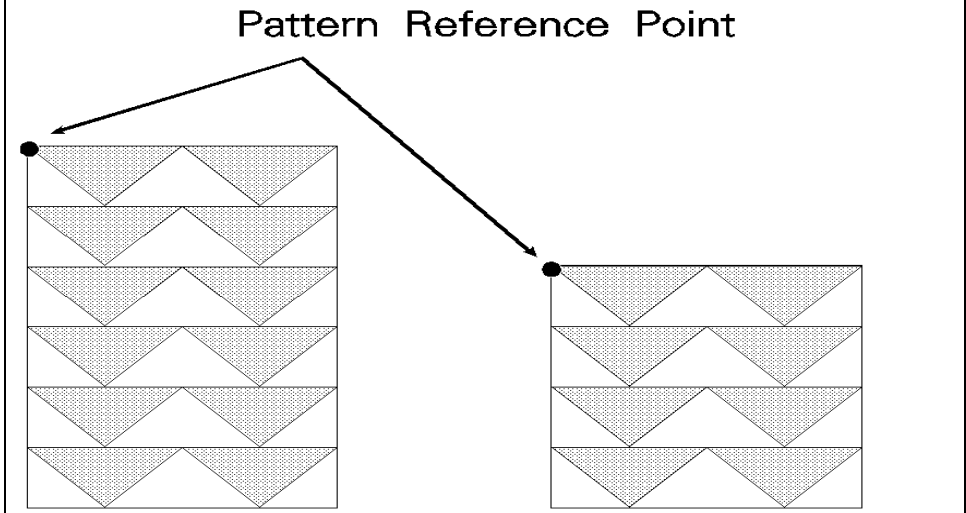

Figure 5-11 Moving Pattern Reference Point for Pattern Filling

Download Pattern Command

The Download Pattern command provides the means for downloading the binary pattern data that defines the user pattern.

$E_C * c \# W$ [pattern data]

= Number of pattern data bytes

Default = 0

Range = 0 – 32767 (HP Color LaserJet 8500 extends the range to 0 to 65535; values outside the range are ignored)

The value field (#) identifies the number of pattern data bytes that follow the Download Pattern command. In addition to the binary pattern data, there are eight bytes of pattern descriptor (header) information included in this pattern data. The format for a 300 dpi resolution header is shown in Table 5-5, below.

Table 5-5. User-Defined Pattern Header (300 dpi resolution)

Byte	15 - MSB	8	7	LSB-0	Byte
0	Format (0)		Continuation (0)		1
2	Pixel Encoding (1)		Reserved (0)		3
4	Height in Pixels				5
6	Width in Pixels				7
8	Pattern image				

Format (Byte 0)

This field indicates the downloadable pattern format:

Format 0	1 bit per pixel: black-and-white or foreground color. A “1” bit indicates black or foreground color for a color pattern. A “0” indicates either white or transparency, depending on the source and pattern transparency modes. A “0” cannot be colored.
Format 1	1 or 8 bits per pixel. This format uses the current palette. Data is sent pixel by pixel, and the bits/index field of the pixel encoding byte determines the number of bits defining a pixel.

Continuation (Byte 1)

This field, byte 1, must be set to “0.” (This byte is for future printer support and does not currently provide any continuation operation.)

Pixel Encoding (Byte 2)

The bits/index field may be either 1 or 8. If the value is 1, the color of each pattern dot is specified by a single bit, supporting a two-color palette, which need not be black and white. If the value is 8, the color of each pattern dot is specified by one byte of data, allowing 256 colors. If the value of any byte is greater than the current palette size, the modulo function is applied when rendering.

7	5	4	3	0
000		Unused	Bits/Index	

Reserved (Byte 3)

This field, byte 3, is not currently used and must be set to 0.

Height in Pixels (Bytes 4 and 5)

This field, bytes 4 and 5, identifies the number of raster rows (height) of the pattern, specified at device resolution. If the height is 0, the data is ignored and no pattern is defined. Pattern height must be less than 32767 pixels.

Width in Pixels (Bytes 6 and 7)

This field, bytes 6 and 7, identifies the number of pixels (width) of the pattern, specified at device resolution. If the width is 0, the data is ignored and no pattern is defined. Pattern width must be less than 32767 pixels.

Pattern Image

This field contains the raster data for the pattern. Data rows must be word-aligned. Pattern image data is formatted differently for each format type (see the data description under “Format (Byte 0)” on the previous page).

When using the 300 dpi User-Defined Pattern header (see Table 5-5), set the eight bytes of header information to the following values:

Byte 0 – Format 0 (00 hex)

Byte 1 – Continuation 0 (00 hex)

Byte 2 – Pixel Encoding 1 (01 hex)

Byte 3 – Reserved 0 (00 hex)

Byte 4/5 – Height in Pixels 0 / 16 (00 / 10 hex)

Byte 6/7 – Width in Pixels 0 / 32 (00 / 20 hex)

Byte 8 – Begins the first bytes of binary data.

The PCL code below downloads the user-defined pattern and assigns it an ID number of 3.

1. Specify the pattern ID number:

<code>^C*c3G</code>	Assigns an ID number of 3 to the pattern data which follows.
---------------------	--------------------------------------------------------------

2. Send the User-defined Pattern command:

<code>^C*c72W</code>	Specifies that 72 bytes are to follow (8 bytes for the header plus 64 bytes of pattern data).
----------------------	-----------------------------------------------------------------------------------------------

Send the pattern header and binary data:

```
00 00 01 00 00 10 00 20
FF FF FF FF
7F FF FF FE
3F FF FF FC
1F FF FF F8
0F FF FF F0
07 FF FF E0
03 FF FF C0
01 FF FF 80
00 FF FF 00
00 7F FE 00
00 3F FC 00
00 1F F8 00
00 0F F0 00
00 07 E0 00
00 03 C0 00
00 01 80 00
```

Note

There must be an even number of bytes in user-defined pattern data, hence the trailing zeros (“padding”) in the last eight data rows above.

In the previous example, the raster data code is presented in hexadecimal, however, the numbers in the escape sequences are decimal.

Set Pattern Reference Point Command

The Set Pattern Reference Point command causes the printer to tile patterns with respect to the current cursor position (CAP). This command also specifies whether the pattern rotates with the print direction or remains fixed.

E_C * **p # R**

- # = 0 - Rotate patterns with print direction
- 1 - Keep patterns fixed

Default = 0

Range = 0,1 (values outside the range are ignored)

A value field of 0 rotates the patterns with changes in the print direction (see Print Direction command). For a value field of 1, patterns remain fixed for changes in print direction.

The default pattern reference point is the upper left corner of the logical page at the top margin (position 0,0). If the Set Pattern Reference Point command is not set, the pattern is tiled with respect to the default reference point.

Note

All patterns are rotated for changes in orientation, but the pattern reference point remains the same (refer to “Logical Page Orientation Command” in Chapter 5 of the *PCL 5 Printer Language Technical Reference Manual*).

This command applies to user-defined, shading, and cross-hatch patterns.

Pattern Control Command

The Pattern Control command provides a means for manipulating user-defined patterns.

$E_C * c \# Q$

- # = 0 - Delete all patterns (temporary & permanent)
- 1 - Delete all temporary patterns
- 2 - Delete pattern (last ID # specified)
- 4 - Make pattern temporary (last ID # specified)
- 5 - Make pattern permanent (last ID # specified)

Default = 0

Range = 0, 1, 2, 4, 5 (command is ignored for other values)

For value fields 2, 4, and 5, the Pattern ID ($E_C * c \# G$) command is sent prior to the Pattern Control command to identify the specific pattern to which the Pattern Control command action is applied.

Rectangular Area Fills (Rules)

Rectangular area fills are a special case of source images—the source transparency mode has no effect, since the printer treats the rectangular area as a solid “black” (all 1’s) source.

Rectangular areas may be filled using patterns or textures. The current Pattern ID ($E_C^*c\#G$) selects the pattern, and the Fill Rectangular Area command ($E_C^*c\#P$) tiles an area whose dimensions are specified by the Vertical and Horizontal Rectangle size commands ($E_C^*c\#A$, $E_C^*c\#B$, $E_C^*c\#H$, $E_C^*c\#V$). The rectangular area does not exist and cannot be printed until the Fill Rectangular Area command ($E_C^*c\#P$) has been issued, even though the rectangular area has been specified.

Filling a rectangular area does not change the current active cursor position (CAP). The filled rectangular area is not affected by end-of-line wrap, perforation skip mode, or margins. A rectangular area may extend beyond the margins, but it will be clipped to the printable area of the logical page. Rectangular areas are not affected by graphics resolution ($E_C^*t\#R$).

Except for the absence of white pixels in the source, pattern transparency operates the same way for rectangular area fills as for other sources. The non-white pixels of the pattern are poured through the entire rectangular area onto the destination. The white bits of the pattern are either applied or ignored, based on the pattern transparency mode. If foreground color is used, it is applied to the non-white bits of the pattern prior to pouring (except for user-defined color patterns).

Note

The Pixel Placement command ($E_C^*l\#R$) affects rules.

The commands used to print rectangular area fills are described beginning on the next page.

Horizontal Rectangle Size (PCL Units)

This command specifies the horizontal rectangle size in PCL Units.

$E_C * c \# A$

$\#$ = number of PCL Units (valid to 4 decimal places)

The horizontal rectangle size is clipped to the bounds of the logical page. Values greater than the logical page boundary are acceptable; however, the final output is limited to the printable area of the logical page. Values outside the range of 0 – 32767 are ignored.

The default rectangle size is 0. Power-up and reset return this value to the default.

Horizontal Rectangle Size (Decipoints)

This command specifies the horizontal rectangle size in decipoints.

$E_C * c \# H$

$\#$ = number of decipoints (valid to 4 decimal places)

The horizontal rectangle size is clipped to the bounds of the logical page. Values greater than the logical page boundary are acceptable; however, the final output is limited to the printable area of the logical page. Values outside the range of 0 – 32767 are ignored.

Decipoints are converted into printer dot values, and any fraction of a dot is rounded up to the next full dot size.

The default rectangle size is 0. Power-up and reset return this value to the default.

Vertical Rectangle Size (PCL Units)

This command specifies the vertical rectangle size in PCL Units.

$E_C * c \# B$

$\#$ = number of PCL Units (valid to 4 decimal places)

The vertical rectangle size is clipped to the bounds of the logical page. Values greater than the logical page boundary are acceptable; however, the final output is limited to the printable area of the logical page. Values outside the range of 0 – 32767 are ignored.

The default rectangle size is 0. Power-up and reset return this value to the default.

Vertical Rectangle Size (Decipoints)

This command specifies the vertical rectangle size in decipoints.

$E_C * c \# V$

$\#$ = number of decipoints (valid to 4 decimal places)

The vertical rectangle size is clipped to the bounds of the logical page. Values greater than the logical page boundary are acceptable; however, the final output is limited to the printable area of the logical page. Values outside the range of 0 – 32767 are ignored.

Decipoints are converted into printer dot values, and any fraction of a dot is rounded up to the next full printable dot.

The default rectangle size is 0. Power-up and reset return this value to the default.

Fill Rectangular Area

The Fill Rectangular Area command determines the type of pattern used to fill the rectangle.

$E_C * c \# P$

- # = 0 - Solid black or foreground color
- 1 - Solid white fill
- 2 - Shaded fill
- 3 - Cross-hatch fill
- 4 - User-defined pattern fill
- 5 - Current pattern fill

Default = 0

Range = 0 - 5 (out-of-range values are ignored)

Note

If a foreground color is selected, solid, shaded, and cross-hatch patterns are printed in the foreground color. User-defined patterns are not affected by the foreground color, but can contain color if they are defined as such. Solid white fills are not affected by foreground color.

Black fill—fills the rectangular area with black fill or with the current foreground color.

White fill—erases any fill in the rectangular area (it fills the rectangular area with white fill). Pertaining to white fills, the pattern transparency mode is always “opaque” (that is, the white pixels always have an effect on the destination).

Shaded fill—fills the rectangular area with one of eight shading patterns as specified by the Pattern ID command.

Cross-Hatch fill—fills the rectangular area with one of the six cross-hatched patterns as specified by the Pattern ID command.

User-defined fill—fills the rectangular area with custom pattern data as specified by the Pattern ID command and downloaded by the User-Defined Pattern command.

Current Pattern—fills the rectangular area with the current pattern.

Note

The current pattern is not applied to a rectangular area unless specified by this command.

The order in which data (patterns/rules, text, raster) is received is the order in which it is processed during the rasterization of the page.

The fill or pattern used as the current pattern is selected using the Select Current Pattern ($E_c*v\#T$) command.

Black fill (value field 0), also known as black rule, and the white fill (value field of 1) “patterns” do not have a choice of different patterns, and thus do not require a pattern specification using the Pattern ID command.

The upper left corner of the rectangular area is located at the cursor position when printing a rectangular area. After printing the rectangular area the cursor is returned to the upper left corner; the cursor position does not change positions as a result of printing a rectangular area.

Rectangular areas are independent of the text area and perforation skip mode; these boundaries are ignored (rectangles are not clipped at these boundaries). Addressable rectangular areas are limited to the logical page. Rectangular areas that extend outside the logical page are clipped at the logical page boundaries (refer to the *PCL 5 Printer Language Technical Reference Manual* for logical page and printable area boundary specifications).

The pattern transparency mode controls how the area fill pattern is applied to the page. Refer to the following section for a description of how the pattern transparency mode affects the rectangular fill area.

A white fill “erases” any data placed within the rectangular area, regardless of the transparency mode settings. However, after a white fill erases data within an area, data subsequently placed within that area will be visible.

Pattern Transparency for Rectangular Area Fill

Pattern transparency affects how a pattern is applied to the rectangular fill area. The pattern and pattern type are selected by the Pattern ID command ($E_c*c\#G$) and the Fill Rectangular Area ($E_c*c\#P$) command (described earlier in this chapter).

Note

Source transparency has **no effect** on the rectangular fill area since the rectangular area is viewed as all 1's (a solid black source image).

When applying a pattern (area fill) to the rectangular area, the pattern transparency mode affects the final result the same as it does when filling other images or text. The pattern transparency mode determines the effect white pixels of the pattern have on the destination for value fields 0 (black fill), 2 (shaded fill), 3 (cross-hatch fill), or 5 (current pattern fill) of the Fill Rectangular Area command.

The "0" bits of the fill pattern are either applied (opaque) or ignored (transparent) based on the transparency mode setting (see Figure 5-12). When a value field of 1 (white fill) is used, pattern transparency mode is **always treated as if it were opaque**.

The effect of transparency modes on rectangular areas is illustrated in Figure 5-12. In both examples, the source transparency mode is opaque regardless of the actual setting. In the first example, the pattern transparency mode is transparent; the white pixels in the pattern are not applied to the destination, so that the pattern is visible in only two quadrants of the destination. In the second example, the pattern transparency mode is opaque, and the pattern is visible in the entire rectangular area.

Source Transparency Mode = 0 or 1 (Transparent or Opaque)
Pattern Transparency Mode = 0 (Transparent)

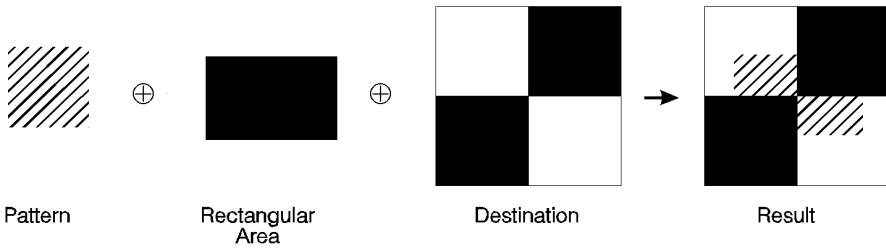

Source Transparency Mode = 0 or 1 (Transparent or Opaque)
Pattern Transparency Mode = 1 (Opaque)

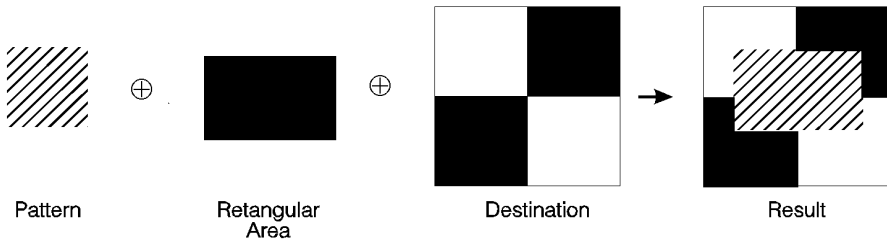

This example is a monochrome example and assumes the default ROP.

Figure 5-12 Effect of Transparency Modes on Rectangular Areas

Rectangular Fill Examples

Following are two examples that demonstrate the way to print and fill rectangular shapes. The first example demonstrates filling rectangles with solid fill and the second example demonstrates filling with a shading pattern.

Solid Fill (Black/White)

To print a 900 by 1500 Unit black rule (3 inches by 5 inches at 300 units-per-inch), then “white fill” a small area inside the black rectangle, perform the following steps.

- 1 Position the cursor:

`Ec*p300x400Y` This moves the cursor to PCL Unit position (300, 400) within the PCL coordinate system.

- 2 Specify the width of the rule:

`Ec*c900A` This sets the rule width to 900 PCL Units (3 inches at 300 units-per-inch).

- 3 Specify the height of the rule:

`Ec*c1500B` This sets the rule height to 1500 PCL Units (5 inches at 300 units-per-inch).

- 4 Print the rule:

`Ec*c0P` This example prints a black filled rectangular area.

- 5 Position the cursor inside the rectangular area:

`Ec*p600x700Y`

- 6 Specify the width and height for the smaller white fill rectangular area:

`Ec*c300a600B`

7 Select the white fill and print.

E_C*c1P

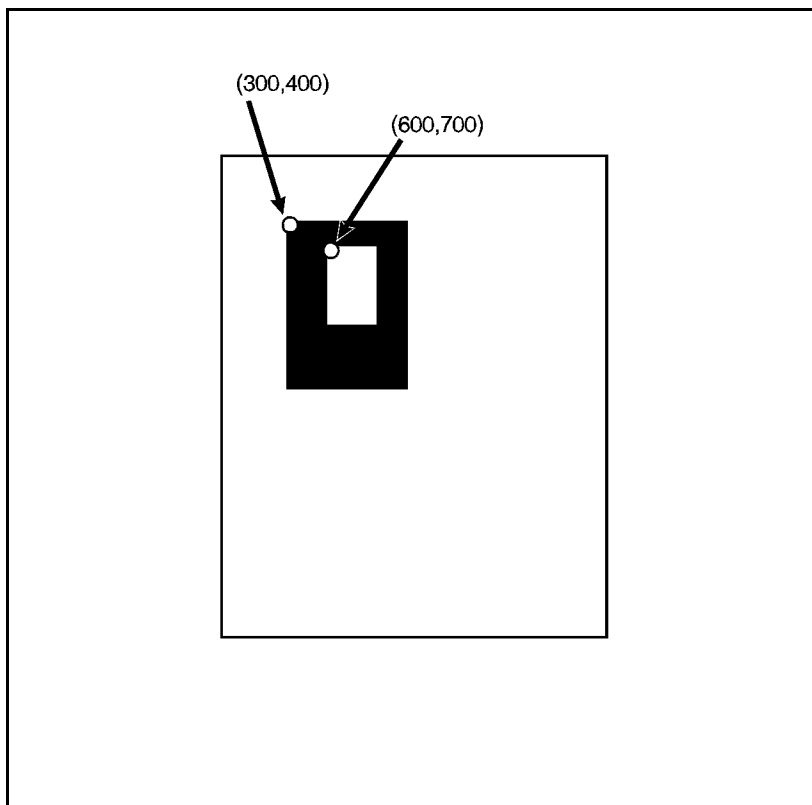

Figure 5-13 Solid Fill Example

Shaded Fill

To print a 900 by 1500 Unit 25% shaded rectangle (3 inches by 5 inches at 300 units-per-inch), perform the following steps.

- 1 Position the cursor:

`E_C*p300x400Y` This moves the cursor to PCL Unit position (300, 400) within the PCL coordinate system.

- 2 Specify the width of the rectangle:

`E_C*c900A` This sets the rectangle width to 900 PCL Units (3 inches at 300 units-per-inch).

- 3 Specify the height of the rectangle:

`E_C*c1500B` This sets the rectangle to 1500 PCL Units (5 inches at 300 units-per-inch).

- 4 Specify the Pattern ID:

`E_C*c25G` This sets the Pattern ID to 25.

5 Print the rectangular shaded area:

E_C^*c2P

This example prints the following:

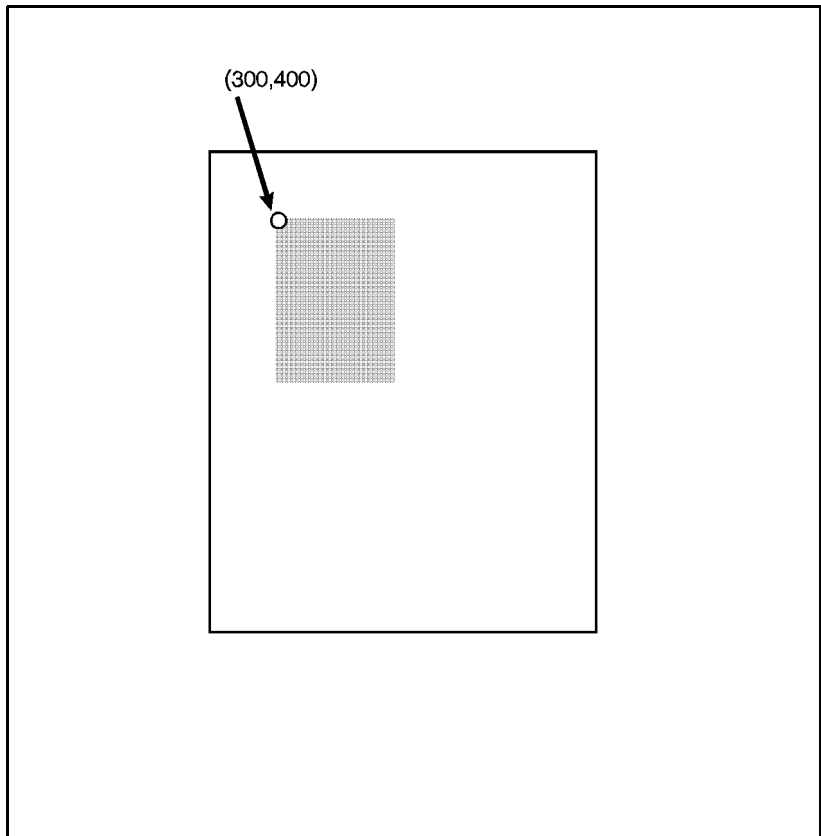

Figure 5-14 Shaded Fill Example

6 Raster Graphics

Introduction

A raster image is a made up of a series of discrete picture elements—pixels. Pictures such as those in newspapers, television, and documents from Hewlett-Packard printers are examples of raster images. In comparison, pictures drawn with lines and geometric objects such as circles, rectangles, and polygons are termed vector graphic images. While some pictures could be produced using either vector or raster graphics, raster graphics is best suited for printing photographic images.

A raster image is invariably rectangular and divided into a gridwork of pixels. Each pixel represents a small area of the image. In monochrome images each pixel represents a black or white dot. In color images each pixel is a colored dot. Therefore, the most important characteristics of an image are its:

- Image width
- Image height
- Image resolution (the number of dots or pixels per inch)

An image is also divided into rows, where a row is a grouping of all the pixels in a horizontal strip of the image, the width of the image and one pixel high.

As noted before, a pixel represents a small area of the image. The size of the area depends on the resolution of the image. The pixel area for a 600 dot per inch (dpi) image is a square 1/600th of a inch on a side. Courser resolutions cover more picture area per pixel. For example, a 75 dpi pixel contains 0.0002 square inches, a 600 dpi pixel contains 0.000003 square inches. Some printing and scanning devices specify a resolution in the horizontal direction and another resolution in the vertical direction, 300 by 600 dpi, for example. However, PCL raster only supports identical resolutions in the horizontal and vertical directions, and therefore, PCL 5 raster graphics pixels are squares.

There is a direct connection between the resolution and the size of an image. The image size is the number of pixels in the image multiplied by the number of bits used to represent a pixel. The smaller the dpi, the smaller the size of the image; the larger the dpi, the larger the size of the image. There is a tradeoff in image size versus print quality. Larger pixels give poorer print quality since diagonal lines can start looking ragged or pixelated, but the image size is small. Smaller pixels give good print quality but larger image size. As a rule, 150 dpi provides a happy medium of good print quality at a relatively small image size.

A printer has a printing resolution, 600 dpi for example. An image with an image resolution smaller than the printer's resolution will undergo a process of scaling as the image is converted to the printer's resolution, also known as device resolution. For example, a 150 dpi image is converted to a 600 dpi image at device resolution by replicating each pixel four times in the horizontal direction and four times in the vertical direction. Therefore, a single pixel of a 150 dpi image is replicated by creating 15 new pixels. A 75 dpi pixel is replicated by creating 63 new pixels.

The large scale replication of pixels for low resolution images is one of the main reasons for poor print quality: first the image detail may be missing from the image because of the large pixel size, and second a blocky, pixelated effect occurs when the pixel is reproduced over and over again. Various techniques have been devised to compensate for this pixelated effect. For example, rather than copy or replicate the pixel, a bi-linear or bi-cubic interpolation algorithm could be used to smooth out the transitions by considering the surrounding pixels when making new pixels. However, this tends to blur edges or sharp transitions that are in the original image. As a rule, better print quality results from higher resolution images, such as 150 or 300 dpi, that use smaller pixels and cause less pixel replication.

Pixels represent specific spots within the picture. In a black and white image, where a pixel is either black or transparent (white), a single binary digit or bit can represent a pixel. This has been the standard raster format for many years. See Figure 6-2 for an example. However, in color images, or grayscale images, those with varying black dot sizes which yield a range of grays when viewed by the human eye, a single bit is not sufficient. Therefore, the general form of a pixel is:

- The number of components in the pixel, which is generally either one or three, and
- The number of bits per component.

This pixel format is sufficient to represent black and white images, gray scale images, and color images. Furthermore, this format can represent images where the color specification is directly in the image, or where the pixel is an index into the palette. The table below shows some possible combinations of the number of components and the bits per component.

Image Type	Number of Components	Bits per Component
Black and White, direct	1	1
Black and White, indexed	1	1
Color, indexed	1	8
Color, direct	3	8

PCL 5 Color Raster Graphics

The PCL 5 color raster graphics command set provides support for specifying an image's:

- Dimensions
- Resolution
- Pixel format, also known as the pixel encoding mode
- Compression mode

Large image size is one of the major concerns with raster images. For example, the size of an 8 x 10 inch monochrome image at 150 dpi is 225 Kbytes. The size of a 24-bit color image with the same size and resolution is 5.4 Mbytes. If the color image is 600 dpi, 24-bit color, its size is 86 Mbytes. Therefore, the PCL 5 language supports several compressions modes that exploit redundancy between adjacent pixels or adjacent rows. Furthermore, several shortcuts are available to avoid sending data that is really large blocks of zeros.

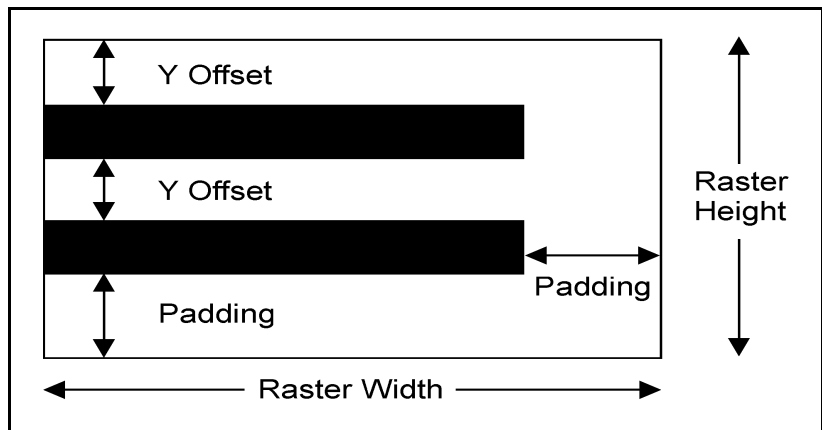

Figure 6-1 Raster Area

An image's width and height define the extent of the image, that is, the number of pixels in a row and the number of rows in the image. The following commands and features eliminate the need to send blocks of zero pixel values:

- 1** The Y Offset command can be used to direct the printer to set all the pixel values in the given number of rows to zero.
- 2** If not enough data is sent for all the pixels in a row, the remaining pixels are set to zero.
- 3** If the image is ended before all rows have been received, the values of the pixels in the remaining rows will be set to zero.

Furthermore, if too much data is sent the data extending outside the raster area is clipped and discarded.

Raster Graphics Command Sequence

PCL raster commands include: Start Raster Graphics and End Raster Graphics commands, Transfer Raster Data by Plane and Row, Raster Compression, Raster Presentation, Raster Resolution, Raster Height and Raster Width (which define the raster area), and Raster Y Offset commands. For printing well-behaved raster graphics, the normal sequence of execution for these commands is shown below. Hewlett-Packard strongly recommends that developers use this command sequence in their applications.

Note

Although the source raster height and width commands are not necessary, they improve memory efficiency.

Well-Behaved Raster Command Sequence

```
Raster Presentation
Raster Resolution
Raster Height
Raster Width
Start Raster Graphics
Y Offset
Raster Compression
Transfer Raster Data
...

Transfer Raster Data
Y Offset
Transfer Raster Data
...

Y Offset
Raster Compression
Transfer Raster Data
...

Raster Compression
Transfer Raster Data
End Raster Graphics
```

The emphasis in the previous command sequence is that the Raster Presentation Mode, Raster Resolution, Raster Height, and Raster Width are all set outside the *start..data..end* sequence of commands. Also, the entire image is sent during the *start..data..end* sequence, choosing the most effective compression method for each raster row of data.

Raster Presentation, Raster Resolution, Raster Height, Raster Width, and Raster Compression are all true modes. Once specified, the printer remains in that mode unless explicitly changed by issuing the command again, or reset to default values by a soft reset, self test, font printout, or power cycle.

Note

Only raster data appearing within the intersection of the logical page, the printable area, the raster width, and height is printed. If raster width and/or raster height have not been set, the intersection of the logical page and the printable area determines where raster graphics appear; raster data is clipped to the printable area.

Raster Graphics Resolution Command

Raster graphics can be printed at various resolutions. This command designates the resolution of subsequent raster data transfers in dots per inch.

E_C * **t # R**

= 75 - 75 dots-per-inch
100 - 100 dots-per-inch
200 - 200 dots-per-inch
150 - 150 dots-per-inch
300 - 300 dots-per-inch
600 - 600 dots-per-inch

Default = 75

Range = 75, 100, 150, 200, 300, 600

This command must be sent prior to the start graphics command. The factory default resolution is 75 dots-per-inch.

Note

Lower resolution graphics occupy less user memory. For example, the number of bits required to represent a two-inch by three-inch image at 75 dots-per-inch is 33,750. The same image at 300 dots-per-inch requires 540,000 bits. Note that lower resolution graphics may not give acceptable print quality.

When configured for 300 dpi resolution, the printer automatically expands raster graphics transferred at resolutions less than 300 dots-per-inch to 300 dots-per-inch during printing. Figure 6-2 illustrates how a single bit is translated into the corresponding printed dots in various graphics resolutions when the printer is configured for 300 dpi.

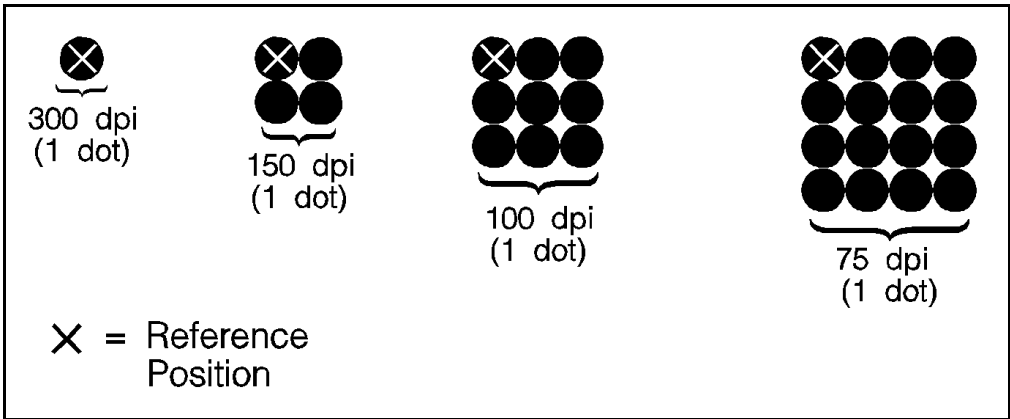

Figure 6-2 Raster Graphics Expansion - at 300 dpi

Note

Rectangular area fills and character data are not affected by changes in resolution. Rectangular Area fills and character data always print at the maximum resolution, regardless of the resolution setting.

Raster Graphics Presentation Mode Command

The Raster Graphics Presentation command specifies the orientation of the raster image on the logical page.

$E_C * r \# F$

- # = 0 - Raster image prints in orientation of logical page
- 3 - Raster image prints along the width of the physical page

Default = 3

Range = 0, 3

- A value of **0** indicates that a raster row will be printed in the positive X-direction of the PCL coordinate system. (The print direction translates the PCL coordinate system.)
- A value of **3** indicates that the raster graphics will be printed along the width of the physical page, regardless of logical page orientation. In portrait orientation, a raster row is printed in the positive X-direction of the PCL coordinate system and a subsequent raster row is printed beginning at the next dot row position in the positive Y-direction. In landscape orientation, a raster row is printed in the positive Y-direction of the PCL coordinate system and a subsequent raster row is printed beginning at the next dot row position in the negative X-direction. Figures 6-3 and 6-4 illustrate presentation modes 0 and 3.

Raster Presentation Mode	Orientation	Default Graphics Margin
0	portrait	logical page left bound
0	reverse portrait	logical page left bound
0	landscape	logical page left bound
0	reverse landscape	logical page left bound
3	portrait	logical page left bound
3	reverse portrait	logical page left bound
3	landscape	50 dots in from the logical page top bound
3	reverse landscape	50 dots in from the logical page top bound

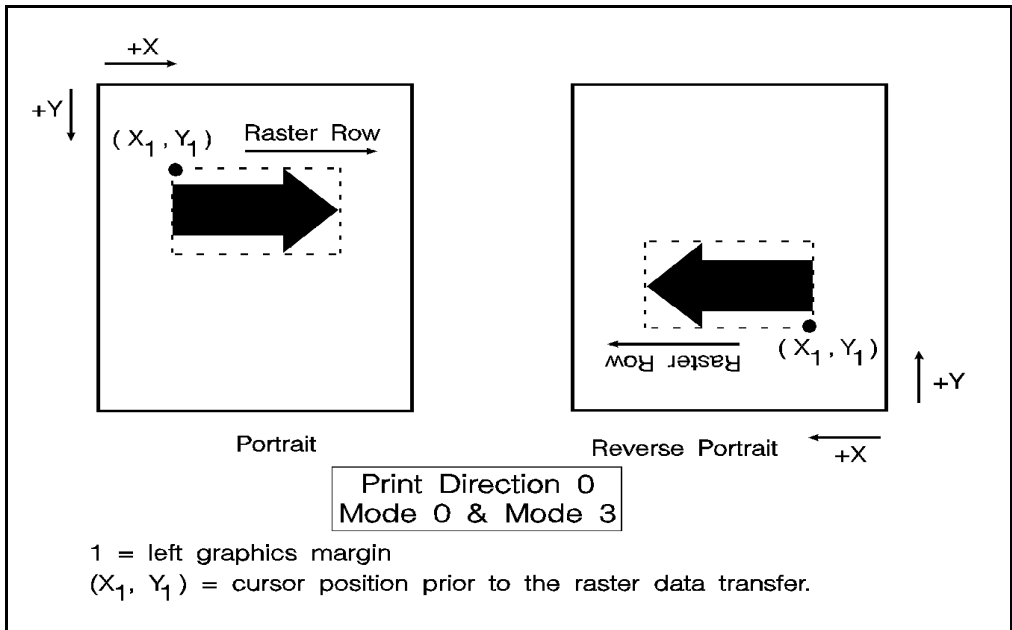

Figure 6-3 Raster Graphics Presentation Mode for Portrait Orientation

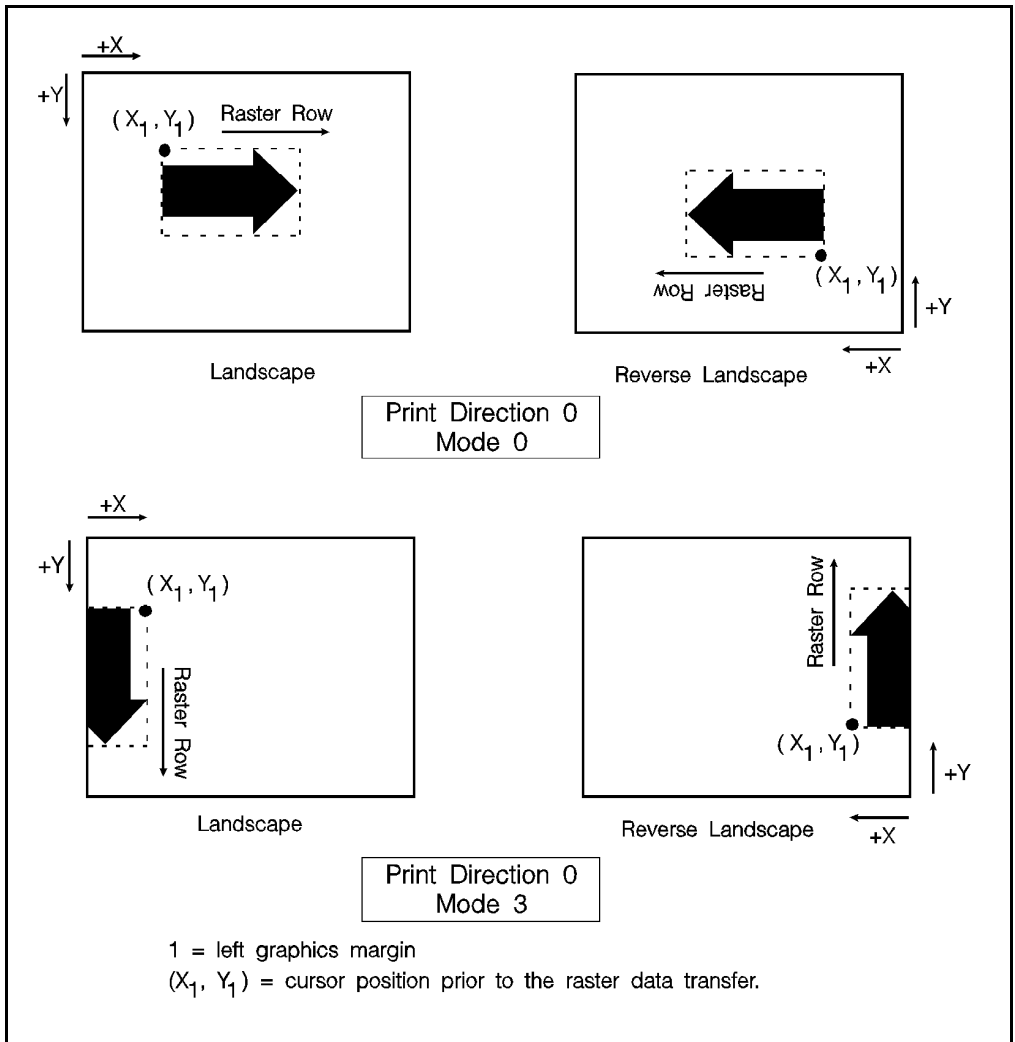

Figure 6-4 Raster Graphics Presentation Mode for Landscape Orientation

Source Raster Height Command

The Raster Height command specifies the height in raster rows of the raster area. Height is the direction perpendicular to the direction that raster rows are laid down, hence, height is subject to the current raster presentation mode and print direction (see Figure 6-5).

$E_C * r \# T$

= Height in raster rows

Default = N/A

Range = 0 to (logical page length – current Y- position of the 0, cursor)*

* Greater values default to (logical page length - current Y cursor position).

Note

Specifying the raster width and raster height improves memory usage. Therefore it is highly recommended.

This command fills the raster area to the full raster height with zeroed rows. Unspecified rows map to either white or transparent depending on the source transparency mode (this is true only if index 0 is white).

When a Transfer Raster Data command is received that causes any raster row to extend beyond the row boundary set by the Raster Height command, the row outside the boundary is clipped. This includes the case where the cursor is moved beyond the height boundary with a Raster Y Offset command and the printing of raster data is attempted.

If you have specified either a raster height or a raster width of 0 and a Start Raster Graphics (or Transfer Raster Data) command is received, then the entire raster graphic is clipped. If both a raster height and a raster width are specified (non-zero) and a Start Raster Graphics (or Transfer Raster Data) command is received, then the raster area is guaranteed to be filled.

Note

For color printers, a zero fill is not necessarily white.

If the raster height is not set, no padding or clipping of rows takes place.

This command is ignored after the Start Raster Graphics or Transfer Raster Data commands until the next End Raster Graphics command.

Note

Only raster data appearing within the intersection of the logical page, the printable area, and if set, the raster width and height, is printed. Data outside the intersection is clipped.

Upon receiving an End Raster Graphics (E_c^*rC) command, the cursor position is set to the left graphics margin of the next raster row after the raster height boundary.

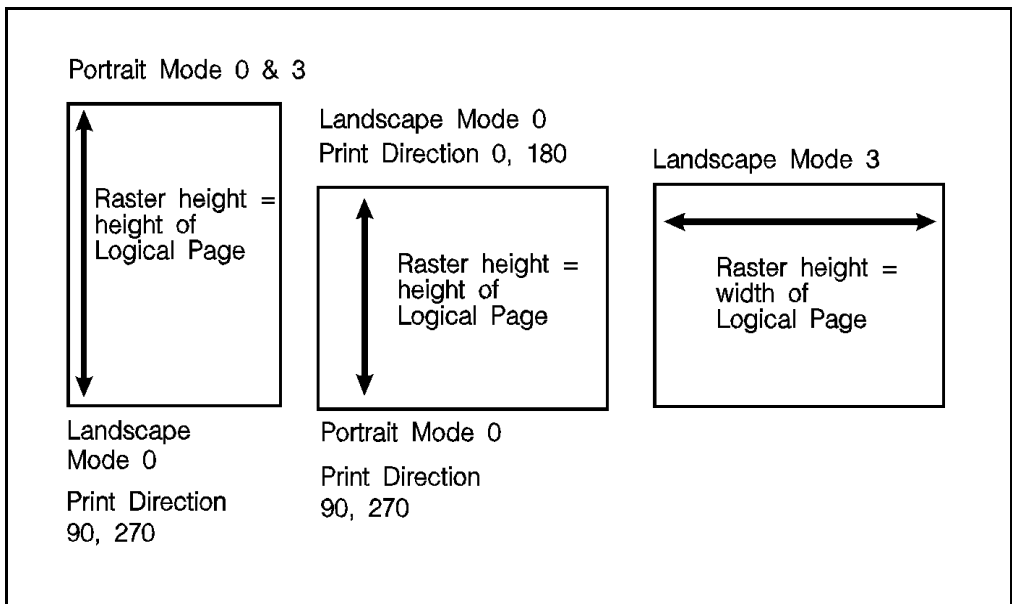

Figure 6-5 Maximum Raster Height

Source Raster Width Command

The Raster Width command specifies the width in pixels of the raster area. Width is in the direction that the raster rows are laid down, hence width is subject to the current raster presentation mode and print direction (see Figure 6-6).

$E_C * r \# S$

$\#$ = Width in pixels of the specified resolution

Default = depends on raster presentation mode: when presentation mode is 0 then width = width of logical page minus left graphics margin; when presentation mode is 3 then width = dimension of logical page along paper length minus left graphics margin.

Range = 0 to (logical page width minus left graphics margin)*

* Greater values default to the (logical page width – left graphics margin).

Note

Specifying the raster width and raster height improves memory usage. Therefore it is highly recommended.

This command allows you to implicitly tell the printer to pad raster rows that are not specified for the full raster width with zeros. Unspecified data maps to either white or transparent depending on the source transparency mode (this is true only if index 0 is white).

Note

For color printers, a zero fill is not necessarily white.

When a Transfer Raster Data command is received that specifies a row of data that is longer than the raster width, the data that extends beyond the raster width is clipped.

This command is ignored after the Start Raster Graphics or Transfer Raster Data commands, until the next End Raster Graphics command.

Note

Only raster data appearing within the intersection of the logical page, the printable area, and if set, the raster width and height is printed. Data outside the intersection is clipped.

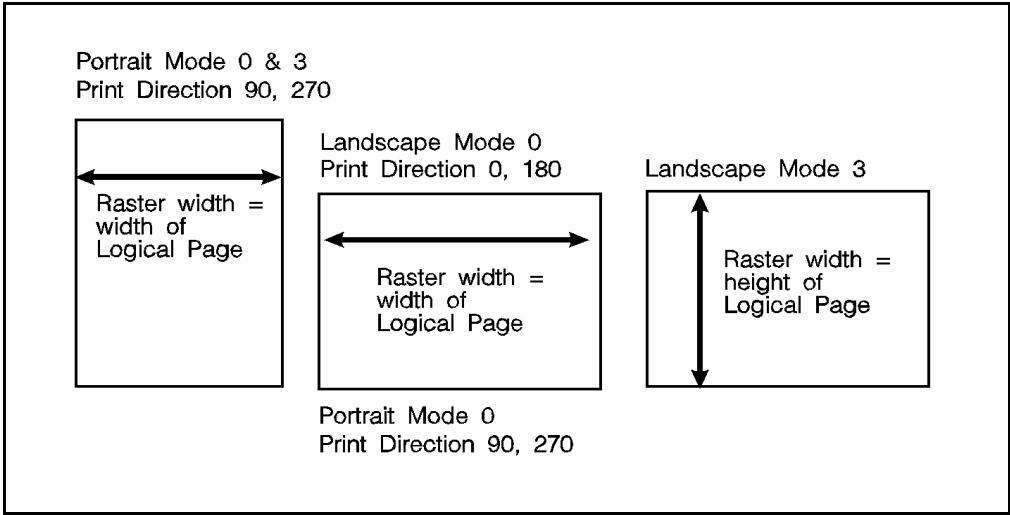

Figure 6-6 Maximum Raster Width

Start Raster Graphics Command

The Start Raster Graphics command identifies the beginning of the raster data and also specifies the left graphics margin.

$E_C * r \# A$

- # = 0 - Start graphics at default left graphics margin (X-position 0).
- 1 - Start graphics at current cursor position (current X-position).
- 2 - Raster scaling on—start at left boundary.
- 3 - Raster scaling on—start at CAP.

Default = 0

Range = 0 - 3 (out-of-range values default to 0)

A value of 0 specifies that the left graphics margin is at the default left margin of the page (X-position 0). A value of 1 specifies that the left graphics margin is at the current X-position. Values of 2 or 3 are equivalent to 0 and 1, but also enable resolution-independent scaling. In presentation mode 3, the location of the left graphics margin varies depending on the orientation.

Once a Start Raster Graphics command is received by the printer, raster graphics resolution, raster graphics presentation mode, raster height, raster width, and left raster graphics margin are fixed until an end raster graphics command is received.

Once in Raster Graphics Mode, PCL commands and text imply an End Raster Graphics ($E_C * r C$) except for the following commands:

- Transfer Raster Data by Row or by Plane
- Set Raster Compression Method
- Raster Y Offset

In addition, the following commands are ignored (i.e., locked out) while in Raster Graphics Mode and do not imply an End Raster Graphics command:

- Start Raster Graphics
- Set Raster Width
- Set Raster Height
- Set Raster Presentation Mode

- Set Raster Graphics Resolution
- Palette Commands
- CID Command
- Color Treatment
- Render Algorithm

Note

An implied End Raster Graphics resets the Raster Compression Method 3 seed row, but does not reset the Raster Compression Method nor the left raster graphics margin.

If source and/or transparency modes have been set, frequent start/end graphics commands in an image can result in a memory overflow condition.

Raster Y Offset Command

The Raster Y Offset command moves the cursor position vertically the specified number of raster lines from the current raster position in the raster area.

$E_C * b \# Y$

$\#$ = Number of raster lines of vertical movement

Default = N/A

Range = 0 - 32767

This command is recognized only while in raster graphics mode and only within the raster area.

This command zero-fills the offset area. For color printers, zero-fills are filled with the color of index 0, which is not necessarily white.

For Delta Row compression (method 3), this command zeros the seed row. For Adaptive compression (method 5), this command applies to the entire raster data block.

Note

Movement by this command is based upon the Raster Resolution setting ($E_C * t \# R$) and also the printer's resolution setting (75, 150, or 300 dpi).

Set Compression Method Command

The Set Compression Method command allows you to encode the data in a given raster transfer, either by plane or by row. These methods achieve data compression by exploiting byte-to-byte redundancies, either within a row or between rows, without regard to the pixel encoding mode of the data. While these methods reduce the amount of data transferred from the host to the printer, they do not reduce the memory requirements within the printer.

While PCL 5 compression methods are based on redundancies at the byte level, the pixel encoding mode must be considered when choosing a compression method. The direct by pixel mode transfers the three bytes which make up a pixel, one after the other. Therefore, compression formats that depend upon reducing redundancy within a row will not do well, since the pixel to pixel redundancy is disguised by the format. This is because, while two adjacent pixels have a fairly high probability of being identical, the probability that the components of a pixel are identical is very small. For example, consider a raster image whose background is all one color. While there are a large number of pixels that are identical, the only time the bytes within the pixel will be identical are if the color is a gray somewhere between white and black: such as (0, 0, 0), (128, 128, 128), (255, 255, 255). If the pixel represents a non-gray color, the bytes within the pixel will not be identical. Therefore, the only successful compression mode that exploits redundancy between the rows is delta row compression. Since the probability that a pixel is the same in the horizontal direction is usually equivalent to the probability that it is the same in the vertical direction, the bytes within a pixel will be redundant and therefore compressible from row to row.

The remaining pixel encoding modes: index by plane, index by pixel, and direct by plane, can be redundant within a row and are, therefore, compressed well by compression methods such as run-length encoding, and TIFF rev 4.0.

The Set Compression Mode command has the following form:

$E_C * b \# M$

- # = 0 - Unencoded
- 1 - Run-length encoding
- 2 - Tagged Image File Format (TIFF) rev. 4.0
- 3 - Delta row compression
- 5 - Adaptive compression

Default = 0

Range = 0 - 3, 5 (other values are ignored)

Unencoded (Method 0)

This is a simple transfer of binary data without any compression.

Run-length Encoding (Method 1)

Run-length encoding interprets raster data in pairs of bytes. The first byte of each pair is the repetition count for the data in the second byte. The second byte is the raster data to be printed. A repetition count of 0 signifies the pattern in the data byte is not repeated (it occurs only once). A repetition count of 1 signifies the pattern occurs twice. The repetition count can range from 0 to 255 for a repetition of 1 to 256 times.

[(Repetition count byte 0-255)(pattern byte)] . [.] []

Tagged Image File Format Encoding (Method 2)

Tagged Image File Format encoding interprets raster data as TIFF "Packbits." This format combines features of methods 0 and 1. A **control byte** precedes the raster data (pattern bytes). The control byte identifies whether the pattern byte(s) represent a byte that is to be repeated some number of times (up to 127), or represent some number of bytes (up to 127) which are to be printed as is (literally).

The sign of the number in the control byte identifies whether the byte or bytes that follow represent a literal pattern or byte to be repeated. A positive number (1 to 127) indicates that the bytes are literal. A negative number (-1 to -127), represented by the twos complement, indicates a repeated byte. The value of the number, if positive (literal), identifies the number of pattern bytes which follow the control byte; if negative (repeated), it identifies the number of times to repeat the following byte. A pattern byte may be repeated up to 127 times; or up to 127 literal bytes may follow the control byte.

As mentioned, for a byte to be repeated, the control byte must be a negative value as represented by the twos complement. For example, to repeat a pattern three times would require the twos complement of the number 3. The twos complement is computed as follows. The binary of 3 is 00000011. Complement each bit to get 11111100, then add one to this value to produce 11111101, the twos complement. The decimal value of this number, 253, used in the control byte, produces a repetition of 3 bytes for a total of 4 occurrences of the pattern.

The range of numbers for the control byte is shown below.

Literal Pattern Values

# of Bytes	Binary value	Decimal value
1	0000 0000	1
to	to	to
127	0111 1111	127

No Operation Value

NOP value	Binary value	Decimal value
128 (-128)	1000 0000	128

Repeated Pattern Values

# of Repetitions	Binary value*	Decimal value
1 (-1)	1111 1111	255
to	to	to
127 (-127)	1000 0001	129

* These negative values are represented by taking the twos complement of the value of the number.

Note

Another method to calculate the number needed in the control byte for some number of repetitions is to subtract the number of desired repetitions from 256. For example, the control value for 3 repetitions (4 occurrences) of a byte is 256 minus 3 = 253.

A zero or positive value in the control byte means that the subsequent byte or bytes are non-replicated bytes of data. The value of the control byte *plus one* indicates the number of data bytes that follow. For example, a control byte of 0 means the following 1 byte is literal raster data. A control byte of 6 indicates that the following 7 bytes are literal raster data bytes.

TIFF encoding also allows you to include a non-operative (NOP) control byte, represented by the value -128. This byte is ignored, and the subsequent byte is treated as the new control byte.

Note

It is more efficient to code two consecutive identical bytes as a repeated byte. If these bytes are preceded and followed by literal bytes, however, it is more efficient to code the entire group as literal bytes.

Examples: Run-length and TIFF Compression

The following examples show how a raster row can be coded using run-length and TIFF compression methods. Note that the compression examples use characters to represent the binary data stream.

Byte Number	#1	#2	#3	#4	#5	#6	#7
Bits	01010101	01010101	01010101	01010101	01000001	01010100	01010100
ASCII	U	U	U	U	A	T	T

Unencoded

```
Ec*r1A
Ec*b0m7WUUUUATT
Ec*rC
```

Run-length Encoding

E_C*r1A
 $E_C*b1m6W(-3)U(0)A(1)T$
 E_C*rC

TIFF Encoding

E_C*r1A
 $E_C*b2m6W(-3)U(0)A(-1)T$ or $E_C*b2m6W(-3)U(2)ATT$
 E_C*rC

In the TIFF encoding example above, parenthetical expressions are used to identify control bytes. For example, the byte (-3) is shown to represent the control byte for a repetition (minus value) of 3. The actual value for this position is the decimal value 253. Additional “encoded” control bytes in this sequence include: (0) for decimal 0, (-1) for decimal 255, and (2) for decimal 2. The raster data (pattern) bytes are represented by the ASCII character.

Delta Row Compression (Method 3)

Delta row compression identifies a section of bytes in a row that is different from the preceding row, and then transmits only that data that is different (the delta data). If a row is completely different from its preceding row, then the entire row must be sent as the delta, which is not very efficient; if only one bit is different, then only one byte is identified and sent. To reassemble the raster data rows, the printer takes the current row (the seed row) and makes the changes indicated by the delta data, to create the new row. The new row (which becomes the new seed row) is used by the next delta compression data to create another row.

A delta compression row consists of two parts, a command byte and the replacement bytes, as shown below:

[(Command byte)(1 to 8 Replacement bytes)]

The command byte identifies two things: 1) the number of replacement (delta) bytes that follow; and 2) where to position the replacement byte string (the left offset). The replacement bytes are some number (up to eight bytes) of consecutive bytes that are used to create the new row from the seed row.

7	5	4	0
Number of bytes to replace (1-8)		Relative offset from last untreated byte	

If more than eight replacement (delta) bytes are needed, additional command byte/replacement bytes may be added, as shown below:

$E_C * 3m \# W$ [(Command Byte)(1 to 8 Replacement Bytes)][(Command Byte)(1 to 8 Replacement Bytes)]. . .

In the command byte, the upper three bits identify the number of replacement (delta) bytes (which can be 1 to 8 bytes). The lower five bits identify the location the replacement bytes are to be positioned. This position is identified as the **offset**, or the number of bytes from the treated byte. For example, if there are 5 replacement bytes and the offset is 7, then the replacement bytes replace bytes 7, 8, 9, 10, and 11 (the five bytes beginning at byte 7 from the seed row).

If there is more than one replacement in a row, the second offset is counted from the next untreated byte in the row: the first byte following the last replacement byte.

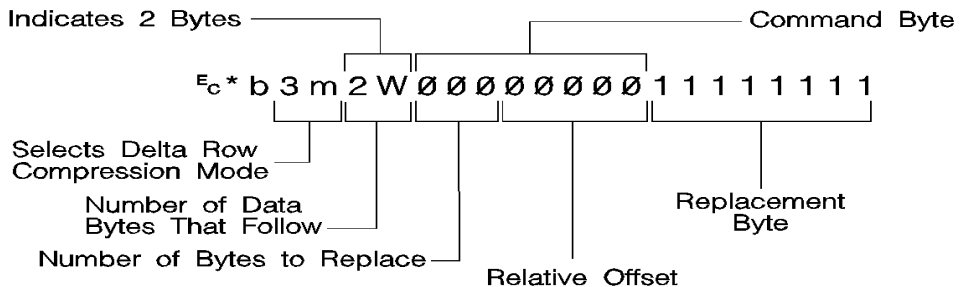

As mentioned, the offset contained in the lower five bits of the command byte allows for offset values from 0 to 31. Compression mode allows offsets larger than 31 bytes as follows:

- An offset value of 0-30 indicates that the replacement bytes are offset from the 1st byte to the 31st byte.
- A value of 31 indicates that the next byte following the command byte is an additional offset byte which adds to the first (32) offset value. This allows offset values larger than 31. Also, if this second offset byte is set to 255 (all ones), additional offset bytes follow until the required offset value is obtained. When the formatter detects an offset byte less than 255, it is assumed to be the last offset value and the offset bytes are then totaled (added). The following example shows an offset larger than 31:

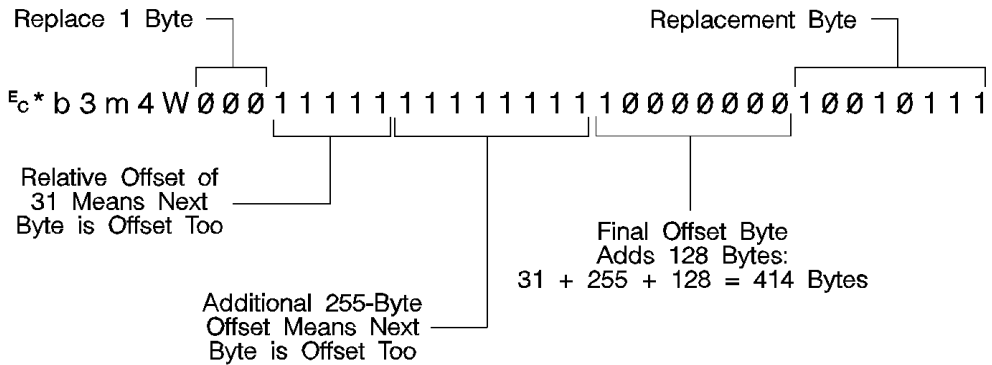

The total offset is 414, which is the sum of the three offset values: $31 + 255 + 128$.

Seed Row

The seed row is basically the current raster data row, the row being printed. It is maintained by the printer for use by delta row compression. The delta compression replacement bytes are applied to the seed row to create the new row. This new data row is printed and becomes the new seed row.

For color raster images, the printer operates on each plane independently, and a separate seed plane is maintained for each graphic plane. A Y offset, however, affects all planes and seed rows simultaneously.

The seed row is updated by every raster graphic transfer, regardless of the compression method. This allows the delta compression method to be mixed with other methods to achieve better compression performance.

Repeating a Row

$E_C * b 0 W$

When using the delta compression method, it is possible to repeat or copy the previous raster row using the Raster Data Transfer command. This is accomplished by setting the Raster Data Transfer command value field to zero.

Printing A Zeroed Row (Setting the Seed Row to Zero)

$E_C * b 1 Y$

It is possible to print a row of all zeros using the Raster Y-Offset command. Sending a Raster Y Offset command with a value field of 1 sets the seed row to zero and prints the zeroed row. Note that the next delta row is applied to a zeroed seed row.

Other cursor position moves set the seed row to zeros. (Remember, non-graphic cursor moves have the same effect as an end graphics command.)

Note

If the byte count of the Transfer Raster Data command value field is less than the number of bytes that can be replaced, the byte count has precedence. Also, if the last byte is a control byte, it is ignored. Therefore, $E_C * b 1 W$ does not affect the seed row, but causes the previous row to be replicated.

Example: Delta Row Compression

The following example demonstrates how to compress the following data using the delta row compression. (The bytes highlighted in bold type indicate those bytes needing replacement – those bytes that are different from the previous row, the seed row.)

Byte No.	0	1	2	3	4
Row 1	00000000	11111111	00000000	00000000	00000000
Row 2	00000000	11111111	11110000	00000000	00000000

Row 3 **00001111 11111111 11110000 10101010 10101010**

$E_C * r1A$ – The *start raster graphics* command initializes the seed row to all zeros.

Row 1 – $E_C * b3m2W(00000001)(11111111)$

The **3m** selects the delta row compression method and the **2W** indicates 2 bytes of data to follow. The first three bits of the first data byte, the command byte, signify a single byte replacement (all three bits are 0). The next five bits indicate an offset of 1 byte from the current position. The replacement byte follows and contains **11111111**.

Row 2 – $E_C * b2W(00000010)(11110000)$

The first three bits of the command byte indicate that one byte will be replaced, and the next five bits indicate a relative offset of 2, so the replacement will occur 2 bytes from the current position. The replacement byte follows and contains 11110000.

Row 3 – $E_C * b5W(00000000)(00001111)(00100010)(10101010)(10101010)$

As in the other rows, the first three bits of the command byte are zero, indicating a single byte replacement. The five offset bytes indicate a relative offset of zero bytes. The replacement byte follows and is 00001111. The third byte is another command byte and the first three bits signify the replacement of two bytes (the top three bits are 001). The offset bits indicate an offset of two bytes from the current position. The fourth and fifth bytes are the two replacement bytes.

Adaptive Compression (Method 5)

Adaptive compression enables the combined use of any of the four previous compression methods (0 through 3), and it includes the ability to print empty (all zeros) rows or to duplicate rows.

Adaptive compression interprets a raster image as a block of raster data rather than as individual rows. The result of this interpretation is that the Transfer Raster Data ($E_C * b\#W$) command is sent only once at the beginning of a raster data transfer, and the value field (**#**) identifies the number of bytes in the block of rows. For the other compression methods, the Transfer Raster Data command is sent at the beginning of each row and the value field (**#**) identifies the number of bytes for that row only.

The size of a block is limited to 32,767 bytes. (32,767 bytes is the number of compressed bytes and not the size of the uncompressed data). To transfer greater than 32,767 bytes, send multiple blocks.

Adaptive compression uses three control bytes at the beginning of each row within the block. The first of these bytes, the command byte, identifies the type of compression for the row. The two following bytes identify the number of bytes or rows involved. The format for adaptive compression raster rows is shown below:

<command byte><# of bytes/rows - upper byte><# of bytes/rows - lower byte> ...
... <first raster row byte> ... <last raster row byte>

The command byte designates the compression method, empty row, or row duplication. Command byte values are shown below.

Value	Compression Operation
0 –	Unencoded
1 –	Run-Length Encoding
2 –	Tagged Image File Format (TIFF) rev 4.0
3 –	Delta row
4 –	Empty row
5 –	Duplicate row

For command byte values 0 - 3, the two **<# of bytes/rows>** bytes specify the number of bytes (row length) for the row. For command byte values 4 and 5, these bytes identify the number of empty or duplicate rows to print. The maximum value for these two bytes is 65,535; however, the image is clipped to the logical page. Thus, the value of these bytes should not exceed the maximum number of bytes/rows that can be printed on the current logical page size.

If an out-of-range command byte is encountered, the remainder of the block is skipped, the cursor is not updated, and the seed row is cleared.

Compression methods 0 - 3 are the compression methods used by the Set Compression Method command. Value fields 4 and 5 are features for the adaptive compression method and are explained below.

Empty Row

A command byte of 4, empty row, causes a row of zero's to be printed. The number of rows printed depends on the value contained in the two **<# of bytes/rows>** bytes following the command byte. The empty row operation resets the seed row to zero and updates the cursor position.

Duplicate Row

A command byte of 5, duplicate row, causes the previous row to be printed again. The row can be duplicated the number of times indicated by the value contained in the **<# of bytes/row>** byte. Duplicate Row updates the cursor position but does not change the seed row.

Adaptive Compression Operation Hints

Note

Some HP LaserJet printers perform internal compression techniques to support full-page graphics. Refer to Chapter 1 of the *PCL 5 Comparison Guide* for specifics.

- The compression methods cannot be mixed within one raster row. A raster row must be compressed using only one method.
- The cursor position is updated with each row of the raster block. The cursor position is also incremented when a block count of less than 3 is sent.
- A Raster Y-Offset command moves the entire block of raster data and initializes the seed row to zeros. The seed row is set to zero even if the y-offset is zero.
- Block size takes precedence over row length. If the row length of any line exceeds the block size, the row length is truncated to the block size.
- For duplicate and empty rows, a row length value of zero does not update the cursor, however the seed row is initialized to zero.
- If an unsupported command byte for a raster row is encountered, the remaining bytes for the block are skipped, the seed row is cleared, and the cursor is not incremented.
- For method 1, run length encoded, if the row length is odd, the cursor is incremented, the row data is skipped (thrown away), and the seed row is left unchanged.
- For method 1, a row length value of zero increments the cursor and zero fills the seed row.
- For method 2, TIFF, if row length terminates the data before the control byte value is satisfied (literal byte count greater than row length), the data following the control byte, if any, is printed as text. The cursor is incremented.
- For Method 2—if row length is equal to one, the one byte is consumed from the I/O and the cursor is incremented. The data is ignored and the seed row is zeroed.
- For Method 3—delta row compression, within an adaptive compression block, the seed row is updated by every raster compression method or type of row. For example, a row compressed with Method 2, TIFF, updates the seed row, while the effect of an empty row initializes the seed row to zeros. Maintaining the seed row allows Method 3 to be mixed with other methods to achieve optimal compression performance.

- For Method 3—since delta row compression requires that the seed row be available whenever raster graphics mode is entered, the seed row is initialized to zeros upon raster graphics mode entry ($E_C*r\#A$). The seed row is also initialized upon receipt and completion of each raster block.
- For Method 3—if the row length terminates the data before the control byte value is satisfied (literal byte count greater than row length), the data following the control byte, if any, is printed as text. The cursor is incremented.
- For Method 3—if the row length is equal to one, the current row is duplicated and the cursor is incremented.

Transfer Raster Data Commands

There are two Transfer Raster Data commands: *Transfer Raster Data by Plane* and *Transfer Raster Data by Row*.

- **Transfer Raster Data by Plane**—This command ($E_C*b\#V$) is used when the raster data is encoded by plane as specified by the Simple Color command ($E_C*r\#U$) or the Configure Image Data command ($E_C*v\#W$). The *Transfer Raster Data by Plane* command is used to send each plane in the row except the last; the *Transfer Raster Data by Row* command ($E_C*b\#W$) must be used to send the last plane and advance the cursor to the beginning of the next row.
- **Transfer Raster Data by Row**—This command ($E_C*b\#W$) moves the current active cursor position to the next pixel row after its execution. It is used for monochrome printers for the last plane in a multi-plane row, or for color raster transfer when the data is encoded by pixel.

Both commands are described in detail in the following paragraphs. Chapter 2 provides additional descriptions and examples using the Transfer Raster Data commands to print color images.

Transfer Raster Data by Plane

This command sends a plane of data to the printer and advances to the next plane (not to the next row).

$E_C * b \# V$ [*raster data*]

Default = N/A

Range = 0 to 32767

The value field (#) identifies the number of bytes in the plane. The number of planes per row is specified by the Simple Color command ($E_C * r \# U$) or the Configure Image Data command ($E_C * v \# W$), depending on which color mode is used. The first plane sent represents the least significant bit in the pixel.

Since $E_C * b \# V$ does not advance the cursor to the beginning of the next raster row, it cannot be used for the last plane or for single-plane rows. Only $E_C * b \# W$ can advance the cursor to the next row.

The amount of data sent varies from plane to plane and is independent of raster width. Planes shorter than the raster width are zero-filled. Empty planes can be sent using $E_C * b 0 V$.

Note

For monochrome printers, zero indicates a white pixel. For color printers, the color indicated by zero depends on the current palette.

Transfer Raster Data By Row/Block Command

The Transfer Raster Data command is used to transfer a row of raster data to the printer. This command is used for sending all raster graphics data to monochrome printers. It is also used for color printers when encoding the raster data by pixel rather than by plane. When encoding color raster data by plane, this command is used for single-plane rows, or for the last plane in a multi-plane row, since this command advances the cursor position to the beginning of the next raster row.

$E_C * b \# W$ [*raster data*]

Default = N/A

Range = 0 to 32767

The value field (#) identifies the number of bytes in the raster row. These bytes are interpreted as one row of raster graphics data printed at the current Y position at the left raster graphics margin. Upon completion of this command, the cursor position is at the beginning of the next raster row at the left raster graphics margin.

Raster graphics are independent of the text area and perforation skip mode—these boundaries are ignored.

Raster graphic images, raster height, and raster width are limited to the printable area; images that extend beyond the printable area are clipped.

Byte Counts and the TIFF v4.0 Compression Mode

The byte count of the value field in the Transfer Raster Data command has precedence over the literal, or the command byte, byte count of the TIFF v. 4.0 compression mode. For example, the command,

```
^C*b2m3W [binary data]
```

sets compression method=2 (TIFF v. 4.0) and sends 3 bytes of raster data for the row. Suppose the binary data appears as follows:

```
00000010 00000001 00000001 00000001
```

The control (first) byte value of 2 indicates that 3 bytes of literal (unencoded) raster data will follow. The Transfer Raster Data command, however, specified only three bytes total (including the control byte) in the raster row. The control byte and the following two data bytes are read, and the remaining data byte is ignored.

If the last byte indicated by the value field in the Transfer Raster Data command is a control byte, that byte is ignored.

Note

If a Transfer Raster Data command is received without an accompanying Start Raster Graphics command, any preceding start raster values are used (such as left graphics margin, raster height and width, etc.).

End Raster Graphics Command

The End Raster Graphics command signifies the end of a raster graphic data transfer.

$E_C * r C$

Receipt of this command causes 5 operations:

- Resets the raster compression seed row to zeros.
- Moves the cursor to the raster row immediately following the end of the raster area (if a source raster height was specified).
- Allows raster commands which were previously locked out to be processed.
- Sets compression mode to 0 (no compression).
- Defaults the left graphics margin to X-position 0.

Note

This command is a modified version of the $E_C * r B$ End Raster Graphics command. The newer version ($E_C * r C$) performs two additional operations: it resets the compression mode to 0 and defaults the left graphics margin to 0.

This command ($E_C * r C$) is not supported by the HP LaserJet III or the HP LaserJet IIID printers. Use the $E_C * r B$ End Raster Graphics command to terminate raster graphic data transfers for these printers.

Refer to the "PCL Feature Support Matrix" in Chapter 1 of the *PCL 5 Comparison Guide* for specific printers which support these commands.

Raster Scaling

Raster scaling provides the ability to enlarge or reduce raster images using the Destination Raster Width and Destination Raster Height commands. The Start Raster command ($E_C*r\#A$) with a value field of 2 or 3 turns on scale mode. Scaling is independent of device resolution.

Note

To use raster scaling, the Configure Image Data command ($E_C*r\#W$) must be sent prior to the Start Raster command ($E_C*r\#A$), which must have a value field of 2 or 3 to enable scaling.

There are two types of raster scaling: Resolution and Arbitrary. The scaling type is selected by the argument to the Start Raster command. If either 0 or 1 are used then resolution scaling is performed. If either 2 or 3 is used then arbitrary scaling is performed.

Resolution Scaling

This scaling is performed using the raster resolution in combination with the device resolution. For example, if the raster resolution is set to 300 dpi and the device resolution is 600 dpi, then the image is scaled by a factor of two. This type of scaling does not depend on the source or destination raster dimensions.

Arbitrary Scaling

This scaling is performed without regard to the raster resolution which is unaffected by scale calculations. The scaling factor is determined by the source and destination raster dimensions. If the destination dimensions are not specified the graphics margin and printable area are used to calculate destination dimensions while maintaining isotropic scaling so that the entire image fits on the page. If only one destination boundary is specified the other is calculated to maintain isotropic scaling.

The destination width and height commands accept real numbers with up to four decimal places of precision. This level of precision is necessary when converting from decipoints to pixels so that round off errors will not create visible print artifacts such as lines within the image.

Destination Raster Width

The Destination Raster Width command defines the width in decipoints of the destination raster picture denoted by the next Start Raster command, which must have a value field of 2 or 3 (E_C*r2A or E_C*r3A).

$E_C * t \# H$

$\#$ = Width (in decipoints)

Default = Right logical page boundary minus left graphics margin

Range = 0 – 32767.0000 (values outside the range are ignored)

Zero or absent values default the destination width to a value that preserves isotropic scaling.

A specified width that would cross the right physical page boundary is clipped at the right physical page boundary, but the scale factor is maintained.

Destination Raster Height

The Destination Raster Height command defines the height in decipoints of the destination raster picture denoted by the next Start Raster command, which must have a value field of 2 or 3 (E_C*r2A or E_C*r3A).

$E_C * t \# V$

$\#$ = Height (in decipoints)

Default = Bottom logical page boundary minus vertical CAP

Range = 0 – 32767.0000 (values outside the range are ignored)

Zero or absent values default the destination height to a value that preserves isotropic scaling.

A specified height that is longer than the physical page is clipped at the bottom of the physical page, but the scale factor is maintained.

Raster Graphics Example

To transfer an unencoded arrow-shaped raster graphic image (see Figure 6-7) in the shape of an arrow, perform the following steps (notice the well-behaved raster sequence is utilized):

- 1 Position the cursor:

`EC*p300x400Y` Move the cursor to PCL Unit position (300, 400) within the PCL coordinate system.

- 2 Specify Raster Presentation Mode 0:

`EC*r0F` Print raster graphics in the orientation of the logical page.

- 3 Specify the raster graphics resolution:

`EC*t75R` Set raster resolution to 75 dpi.

- 4 Specify the raster graphics height:

`EC*r32T` Specify a raster height of 32 pixels (32 rows of raster data).

- 5 Specify the raster graphics width:

`EC*r32S` Specify a 32-pixel raster width.

- 6 Specify the left raster graphics margin:

`EC*r1A` Set the left graphics margin to the current X position (300).

- 7 Specify the Y offset:

`EC*b0Y` This specifies a Y offset of 0 (this command is not necessary here but shows the proper command sequence).

8 Specify the raster compression mode:

E_C*b0M No compression (unencoded).

9 Transfer the raster data to the printer:

Divide the image into dot rows and transfer each dot row to the printer as a string of bytes, as illustrated on the following page.

10 Signify the end of the raster image transfer:

E_C*rC This example prints the arrow as shown in Figure 6-7.

Example of Raster Graphic Image Data					
Raster Image Data				Command Data	
Dot Row	byte 1	byte 2	byte 3	byte 4	Decimal Equivalent
1	00000000	00000000	10000000	00000000	$E_C*b4W[0, 0,128, 0]$
2	00000000	00000000	11000000	00000000	$E_C*b4W[0, 0,192, 0]$
3	00000000	00000000	11100000	00000000	$E_C*b4W[0, 0,224, 0]$
4	00000000	00000000	11110000	00000000	$E_C*b4W[0, 0,240, 0]$
5	00000000	00000000	11111000	00000000	$E_C*b4W[0, 0,248, 0]$
6	00000000	00000000	11111100	00000000	$E_C*b4W[0, 0,252, 0]$
7	00000000	00000000	11111110	00000000	$E_C*b4W[0, 0,254, 0]$
8	00000000	00000000	11111111	00000000	$E_C*b4W[0, 0,255, 0]$
9	00000000	00000000	11111111	10000000	$E_C*b4W[0, 0,255,128]$
10	11111111	11111111	11111111	11000000	$E_C*b4W[255,255,255,192]$
11	11111111	11111111	11111111	11100000	$E_C*b4W[255,255,255,224]$
12	11111111	11111111	11111111	11110000	$E_C*b4W[255,255,255,240]$
13	11111111	11111111	11111111	11111000	$E_C*b4W[255,255,255,248]$
14	11111111	11111111	11111111	11111100	$E_C*b4W[255,255,255,252]$
15	11111111	11111111	11111111	11111110	$E_C*b4W[255,255,255,254]$
16	11111111	11111111	11111111	11111111	$E_C*b4W[255,255,255,255]$

Example of Raster Graphic Image Data					
Raster Image Data				Command Data	
Dot Row	byte 1	byte 2	byte 3	byte 4	Decimal Equivalent
17	11111111	11111111	11111111	11111111	E _C *b4W[255,255,255,255]
18	11111111	11111111	11111111	11111110	E _C *b4W[255,255,255,254]
19	11111111	11111111	11111111	11111100	E _C *b4W[255,255,255,252]
20	11111111	11111111	11111111	11111000	E _C *b4W[255,255,255,248]
21	11111111	11111111	11111111	11110000	E _C *b4W[255,255,255,240]
22	11111111	11111111	11111111	11100000	E _C *b4W[255,255,255,224]
23	11111111	11111111	11111111	11000000	E _C *b4W[255,255,255,192]
24	00000000	00000000	11111111	10000000	E _C *b4W[0, 0,255,128]
25	00000000	00000000	11111111	00000000	E _C *b4W[0, 0,255, 0]
26	00000000	00000000	11111110	00000000	E _C *b4W[0, 0,254, 0]
27	00000000	00000000	11111100	00000000	E _C *b4W[0, 0,252, 0]
28	00000000	00000000	11111000	00000000	E _C *b4W[0, 0,248, 0]
29	00000000	00000000	11110000	00000000	E _C *b4W[0, 0,240, 0]
30	00000000	00000000	11100000	00000000	E _C *b4W[0, 0,224, 0]
31	00000000	00000000	11000000	00000000	E _C *b4W[0, 0,192, 0]
32	00000000	00000000	10000000	00000000	E _C *b4W[0, 0,128, 0]

The brackets and commas are not part of the raster data command; they are used only to delineate the data.

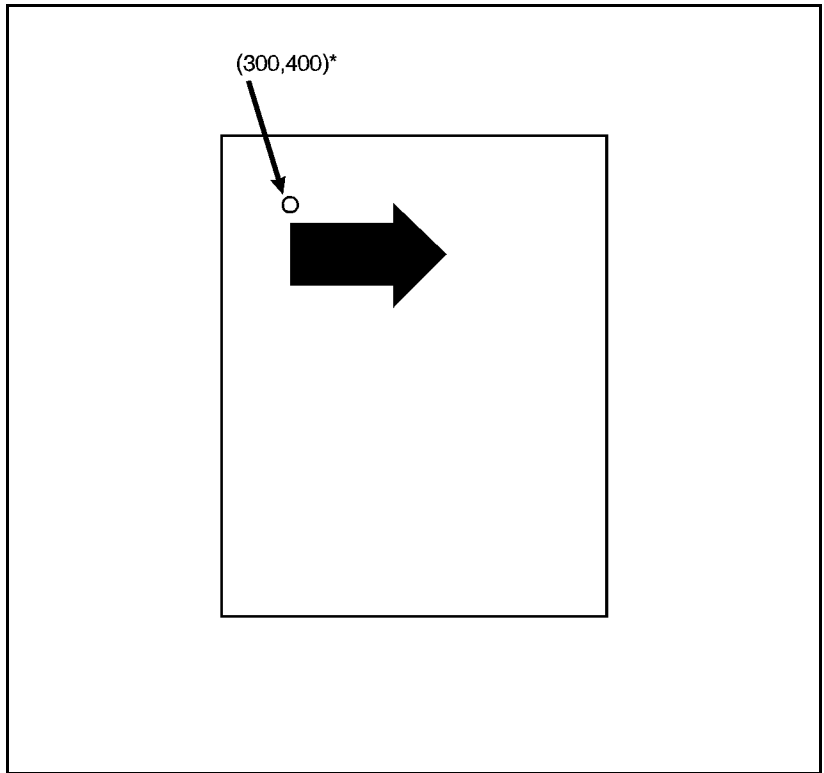

Figure 6-7 Example of Raster Graphic Image Data

Color Raster Graphics Example

This example demonstrates the Indexed by Pixel PEM of the CID command. It produces a one inch wide by one half inch high image of one inch high by 0.1 inch wide colored vertical bars. The pixels in the image are eight byte indices, repeatedly ranging from 0 to 7, thus giving the different colored vertical bars.

The PCL commands are decoded as follows:

PCL Command	Description	Command Arguments
<ESC>E	Reset	
<ESC>*v6W\x00\x01\x08\x08\x08\x08	Configure Image Data	Color space: device RGB Pixel Encoding Mode: indexed by pixel Bits/Index: 8 Bits/Primary 1: 8 Bits/Primary 2: 8 Bits/Primary 3: 8
<ESC>*t600R	Change graphics resolution	600
<ESC>*r600S	Set Source Raster Width	600 pixel units
<ESC>*r300T	Set Source Raster Height	300 pixel units
<ESC>*r0A	Activate graphics mode	
<ESC>*b0M	Compression method	unencoded
<ESC>*b#W	Transfer raster data row (1)	600 bytes
<ESC>*b3M	Compression method	delta row
<ESC>*b#W	Transfer raster data (299)	600 bytes
<ESC>*rC	End raster graphics	
<ESC>E	Reset	

In the textual equivalent of the PCL 5 commands shown below, the following character representations are used:

- \e stands for the ASCII escape character
- \r is a carriage return
- \x00 to \x07 are the single byte, binary values from 00 to 07

7 Color Vector Graphics (HP-GL/2)

Introduction

The process involved in using HP-GL/2 with the HP Color LaserJet family or DeskJet 1200C and 1600C color printers is nearly identical with using HP-GL/2 on other color printers or plotters. However, these two color printers add a few HP-GL/2 commands and expand the functionality of some existing commands. This chapter describes these commands and other pertinent points to keep in mind when using HP-GL/2 with these color printers.

The HP-GL/2 commands explained in this chapter include the following: The Merge Control (MC) command, which functions in a similar way to the PCL logical operation command. The Pen Color (PC) command, which modifies palette colors, the Number of Pens (NP) command, which changes the palette size, the Pixel Placement (PP) command, which determines how pixels are rendered in HP-GL/2 polygons, and the Color Range (CR) command, which sets the range for specifying relative color data (the CR command is not supported by the HP Color LaserJet 4500 or 8500 printers).

In general, when using HP-GL/2 on the HP Color LaserJet family and DeskJet 1200C and 1600C color printers, keep in mind that:

- Palette information stays the same when switching between PCL 5 and HP-GL/2.
- The HP-GL/2 Initialize (IN) command sets the palette to the default eight-pen palette, and also resets the ROP code (see the MC command section later in this chapter) and the pixel placement command.
- As with color plotters, to specify a particular color, you use the SP (Select Pen) command.

If you are not familiar with using HP-GL/2, see the *PCL 5 Printer Language Technical Reference Manual*.

Enter HP-GL/2 Mode

This command causes the printer to interpret subsequent commands as HP-GL/2 commands, instead of PCL printer language commands.

$E_c\%#B$

- # = -1 - Stand-alone plotter mode (single context)
- 0 - Position pen at previous HP-GL/2 pen position
- 1 - Position pen at current PCL cursor position
- 2 - Use current PCL coordinate system and previous HP-GL/2 pen position
- 3 - Use PCL dot coordinate system and the current PCL CAP

Default = 0

Range = 1 to 3 (unsupported negative values default to -1; all other unsupported values are ignored)

As soon as the printer receives this command, it switches to HP-GL/2 mode, interpreting commands as HP-GL/2 commands until it receives an Enter PCL Mode, E_cE , or UEL command, or until the printer power is switched off and on.

The value field (#) determines the cursor position once HP-GL/2 mode is entered.

Note

HP Color LaserJet printers do not support $E_c\%-1B$, $E_c\%2B$, or $E_c\%3B$

- -1 — A value field of -1 creates a “single context” or “stand-alone plotter” mode which has the following effects:
 - The current page is closed and printed and the HP-GL/2 environment is initialized (IN command).
 - HP-GL/2 output begins on a new page.
 - HP-GL/2 and PCL output cannot be combined on the same page.
 - No PCL commands except E_cE , $E_c\%#A$, and the PCL command $E_c\%-12345X$ are recognized by the printer.
 - The PCL picture presentation directives are ignored.

- The $\text{E}_c\%#A$ command closes HP-GL/2, prints the current page, and performs an E_cE before entering PCL.
- The default HP-GL/2 orientation is reverse landscape.
- Hard-clip limits are equal to the printable area.
- The E_cE command functions as usual.

When the single-context mode is used ($\text{E}_c\%-1B$), the following steps should be followed:

- 1 Enter HP-GL/2 mode using the $\text{E}_c\%-1B$ command.
- 2 Transmit one or more HP-GL/2 drawings.
- 3 Exit HP-GL/2 mode ($\text{E}_c\%#A$).
 - **0** — This parameter option ($\text{E}_c\%0B$) sets the pen position to the previous HP-GL/2 position; if this is the first time HP-GL/2 mode is entered in the present print job (assuming an E_cE has been sent), the pen position is at the lower left corner of the PCL Picture Frame (0,0).
 - **1** — This parameter option ($\text{E}_c\%1B$) specifies that the pen position and the label carriage return point become the same as the current PCL cursor position.
 - **2** — $\text{E}_c\%2B$ transfers the current PCL dot coordinate system to HP-GL/2, including the PCL origin and axes, but uses the previous HP-GL/2 pen position as the new pen position. Once the PCL coordinate system is established with this command, it is independent of the P1 and P2 positions.
 - **3** — This parameter option ($\text{E}_c\%3B$) specifies that the pen position and the label carriage return point become the same as the current PCL cursor position. The current PCL dot coordinate system and axes are also transferred to HP-GL/2; once the PCL coordinate system is established with this command, it is independent of the P1 and P2 positions.

When HP-GL/2 is entered using any dual-context mode (any variation of the command except $\text{E}_c\%-1B$), the HP-GL/2 and PCL contexts can be merged, resulting in the following:

- HP-GL/2 and PCL data can be combined on the same page.
- HP-GL/2 graphics can be integrated directly with text.
- The size and location of the PCL picture frame can be specified.
- HP-GL/2 graphics can be scaled to fit within the picture frame.

- The PCL palette and color configuration are transferred between contexts.
- The current logical operation and pixel placement settings are transferred between contexts.
- The current active position (CAP) is transferred between HP-GL/2 and PCL (for $E_C\%1B$ and $E_C\%3B$ only).
- The PCL orientation determines the HP-GL/2 orientation.

In PCL mode, the Enter HP-GL/2 Mode command must be executed, except when in display functions mode or within a binary data transfer. HP-GL/2 ignores this command.

Default Settings when Entering HP-GL/2

When you enter HP-GL/2 mode, most vector graphics variables retain their previous HP-GL/2 value. However, the following changes in the PCL environment can affect the HP-GL/2 environment:

- Resetting the printer ($E_C E$ or control panel reset):
 - Executes an IN (Initialize) command
 - Defaults the PCL Picture Frame size
 - Defaults the PCL Picture Frame anchor point
 - Defaults the HP-GL/2 plot size
 - Defaults the PCL logical page orientation
- A page size, page length, or orientation command:
 - Defaults the PCL Picture Frame anchor point
 - Defaults the PCL Picture Frame
 - Defaults the HP-GL/2 plot size
 - Defaults P1 and P2 (IP, IR commands)
 - Resets the soft-clip window to the PCL Picture Frame boundaries (IW command)
 - Clears the polygon buffer (PM0, PM2)
 - Updates the cursor to the lower-left corner of the picture frame (P1).

- Redefining the PCL Picture Frame size or setting the anchor point:
 - Defaults P1 and P2 (IP, IR commands)
 - Resets the soft-clip window (IW) to the PCL Picture Frame boundaries.
 - Clears the polygon buffer (PM0, PM2)
 - Updates the current pen position to the lower-left corner of the picture frame (P1).
- Setting an HP-GL/2 plot size:
 - Changes the picture frame scaling factor.
- Redefining the palette:
 - Changes colors selected by the Select Pen (SP) command and used in patterns defined by the Raster Fill Definition (RF) command and/or used by the Fill Type (FT) command.

MC (Merge Control)

The MC command controls the color of pixels where two or more page marking primitives intersect on the page. This command supports all 256 Microsoft Windows ternary (ROP3) raster operation codes. A common application of the MC command is the rendering of complex polygon fill patterns. Raster Operations specify how source, destination, and patterns are combined to produce final images.

MC *mode, [opcode][:]*

Parameter	Format	Functional Range	Parameter Default
mode	clamped integer	0 or 1	0 (off)
opcode	clamped integer	0 to 255	252 (mode=0), 168 (mode=1)

- **Mode** — defines the merge control mode as follows:
 - 0** (off, default) Pixels in a primitive replace corresponding destination pixels. If no opcode is specified, 252 is used.
 - 1** (on) Pixels in a primitive merge with corresponding destination pixels, creating a new color based on the colors of the source data and the contents of the destination (frame buffer). If no opcode is specified, 168 is used.

Note

This command is the HP-GL/2 version of the PCL Logical Operation command.

This command sets a ROP value which affects not only HP-GL/2 operation but also the PCL ROP value.

The MC command is defaulted by an IN command.

- **Opcode** — Specifies the logical operations performed on a source, destination, and pattern prior to drawing the final image. These raster opcodes (ROPs) are listed on the following pages in reverse polish notation (RPN) using the following abbreviations:

D — Destination
S — Source
T — Texture
a — and
n — not
o — or
x — exclusive or

For example, when mode = 0, the opcode default is 252, which is the logical function TSo (Texture OR Source).

The operation code (opcode) specifies the logical operations that are performed on a source, destination, and patterned image prior to drawing the final image. The opcodes are created by listing all possible combinations of a single pattern, source and destination pixel, and constructing the desired final pixel values. The following table shows three common opcodes constructed by reading the output values bottom up.

Pixel Combinations			Desired Destination Values		
Pattern Pixel	Source Pixel	Destination Pixel	Source Overwrite	Transparency (TR command)	Source Destination
0	0	0	0	0	0
0	0	1	0	1	1
0	1	0	1	1	1
0	1	1	1	1	0
1	0	0	0	0	0
1	0	1	0	1	1
1	1	0	1	1	1
1	1	1	1	1	0
Resulting Opcode			204 (0xCC)	238 (0xEE)	102 (0x66)

Note

When using the MC command, some pattern types will not produce the expected ROP result. This only occurs when using the FT (Fill Type) command pattern types 1, 2, 3, and 4, and when the ROP includes an XOR operation. (This problem is due to the fact that these patterns are the result of a vector operation and do not produce raster data for use by a ROP operation.) All other Fill Type command patterns (types, 10, 11, 21, or 22) operate as expected.

The MC command supports all 255 Microsoft Windows ROPS, which are listed on the following page in reverse polish notation (RPN) using the abbreviation listed above (D for Destination, S for Source, etc.).

Note

See “Logical Operation Command” in Chapter 5 for usage and ROP selection information.

Table 7-1. Logical Operations (ROP3)

Input Value	Boolean Function	Input Value	Boolean Function
0	0	27	SDTSxaxn
1	DTSoon	28	TSDTaox
2	DTSona	29	DSTDxaxn
3	TSon	30	TDSox
4	SDTona	31	TDSoan
5	DTon	32	DTSnaa
6	TDSxnon	33	SDTxon
7	TDSaon	34	DSna
8	SDTnaa	35	STDnaon
9	TDSxon	36	STxDSxa
10	DTna	37	TDSTanaxn
11	TSDnaon	38	SDTSaox
12	STna	39	SDTSxnox
13	TDSnaon	40	DTSxa
14	TDSonon	41	TSDTSoaxn
15	Tn	42	DTSana
16	TDSona	43	SSTxTDxaxn
17	DSon	44	STDSoax
18	SDTxnon	45	TSDnox
19	SDTaon	46	TSDTxox
20	DTSxnon	47	TSDnoan
21	DTSaon	48	TSna
22	TSDTSanaxx	49	SDTnaon
23	SSTxDSxaxn	50	SDTSoox
24	STxTDxa	51	Sn
25	SDTSanaxn	52	STDSaox
26	TDSTaox	53	STDSxnox

Table 7-1. Logical Operations (ROP3) (continued)

Input Value	Boolean Function	Input Value	Boolean Function
54	SDTox	81	DSTnaon
55	SDToan	82	DTSDaox
56	TSDToax	83	STDSxaxn
57	STDnox	84	DTSonon
58	STDSxox	85	Dn
59	STDnoan	86	DTSox
60	TSx	87	DTSoan
61	STDSonox	88	TDSToax
62	STDSnaox	89	DTSnox
63	TSan	90	DTx
64	TSDnaa	91	DTSDonox
65	DTSxon	92	DTSDxox
66	SDxTDxa	93	DTSnoan
67	STDSanaxn	94	DTSDnaox
68	SDna	95	DTan
69	DTSnaon	96	TDSxa
70	DSTDaox	97	DSTDSaoxxn
71	TSDTxaxn	98	DSTDaox
72	SDTxa	99	SDTnox
73	TDSTDaoxxn	100	SDTSoax
74	DTSDoax	101	DSTnox
75	TDSnox	102	DSx
76	SDTana	103	SDTSonox
77	SSTxDSxoxn	104	DSTDSonoxxn
78	TDSTxox	105	TDSxxn
79	TDSnoan	106	DTSax
80	TDna	107	TSDTSoaxxn

Table 7-1. Logical Operations (ROP3) (continued)

Input Value	Boolean Function	Input Value	Boolean Function
108	SDTax	135	TDSaxn
109	TDSTDoaxxn	136	DSa
110	SDTSnoax	137	SDTSnaoxn
111	TDSxnan	138	DSTnoa
112	TDSana	139	DSTDxoxn
113	SSDxTDxaxn	140	SDTnoa
114	SDTSxox	141	SDTSxoxn
115	SDTnoan	142	SSDxTDxax
116	DSTDxox	143	TDSanan
117	DSTnoan	144	TDSxna
118	SDTSnaox	145	SDTSnaoxn
119	DSan	146	DTSDToaxx
120	TDSax	147	STDaxn
121	DSTDSoaxxn	148	TSDTSoaxx
122	DTSDnoax	149	DTSaxn
123	SDTxnan	150	DTSxx
124	STDSnoax	151	TSDTSoaxx
125	DTSxnan	152	SDTSoaxn
126	STxDSxo	153	DSxn
127	DTSaan	154	DTSnax
128	DTSaa	155	SDTSoaxn
129	STxDSxon	156	STDnax
130	DTSxna	157	DSTDoxn
131	STDSnoaxn	158	DSTDSoaxx
132	SDTxna	159	TDSxan
133	TDSTnoaxn	160	DTa
134	DSTDSoaxx	161	TDSTnaoxn

Table 7-1. Logical Operations (ROP3) (continued)

Input Value	Boolean Function	Input Value	Boolean Function
162	DTSnoa	189	SDxTDxan
163	DTSDxoxn	190	DTSxo
164	TDSTonoxn	191	DTSano
165	TDxn	192	TSa
166	DSTnax	193	STDSnaoxn
167	TDSToaxn	194	STDSonoxn
168	DTSoa	195	TSxn
169	DTSoxn	196	STDnoa
170	D	197	STDSxoxn
171	DTSono	198	SDTnax
172	STDSxax	199	TSDToaxn
173	DTSDaoxn	200	SDToa
174	DSTnao	201	STDoxn
175	DTno	202	DTSDxax
176	TDSnoa	203	STDSaoxn
177	TDSTxoxn	204	S
178	SSTxDSxox	205	SDTono
179	SDTanan	206	SDTnao
180	TSDnax	207	STno
181	DTSDoaxn	208	TSDnoa
182	DTSDTaoox	209	TSDTxoxn
183	SDTxan	210	TDSnax
184	TSDTxax	211	STDSoaxn
185	DSTDaoxn	212	SSTxTDxax
186	DTSnao	213	DTSanan
187	DSno	214	TSDTSoaoox
188	STDSanax	215	DTSxan

Table 7-1. Logical Operations (ROP3) (continued)

Input Value	Boolean Function	Input Value	Boolean Function
216	TDSTxax	236	SDTao
217	SDTSaoxn	237	SDTxno
218	DTSDanax	238	DSo
219	STxDSxan	239	SDTnoo
220	STDnao	240	T
221	SDno	241	TDSono
222	SDTxo	242	TDSnao
223	SDTano	243	TSno
224	TDSoa	244	TSDnao
225	TDSoxn	245	TDno
226	DSTDxax	246	TDSxo
227	TSDTaoxn	247	TDSano
228	SDTSxax	248	TDSao
229	TDSTaoxn	249	TDSxno
230	SDTSanax	250	DTo
231	STxTDxan	251	DTSnoo
232	SSTxDSxax	252	TSo
233	DSTDSanaxxn	253	TSDnoo
234	DTSao	254	DTSoo
235	DTSxno	255	1

PC (Pen Color)

This command changes the pen color in a palette created by the IN or CID command ($E_C*v\#W$). The PC command defaults the colors of all pens as indicated in the table below.

PC [*pen* [,*primary1*, *primary2*, *primary3*;]]

or

PC [*pen*;]

or

PC[:]

Parameter	Format	Functional Range	Parameter Default
pen	integer	determined by NP	see table
primary1, primary2, primary3	clamped real	0 to 255 (for those printers supporting the CR command, the CR command determines the range)	see table

- **pen** — specifies the number of the pen whose color is being defined. An out-of-range pen parameter sets error 3 and the command is ignored. (The range for the pen parameter is determined by the size of the current color palette.)
- **primary1, primary2, primary3** — specifies the primary component values which are to be associated with that pen. See the CR command description for the range associated with the values. If a primary color is outside of the color range defined in the CR command, the value is clamped to the color range limits (the CR command is not supported by the HP Color LaserJet 4500 or 8500 printers).

The “PC;” command defaults the colors of all pens as shown in the table below. The “PC pen;” command defaults the number of pens as shown in the table on the following page for an HP-GL/2 palette. When color device palettes larger than 8 pens default, the first 8 pen colors are as defined for a palette of 8; all remaining pen colors are device- dependent. If the palette is a non-default palette, it defaults in accordance with the default palettes in Chapter 4.

No. of Pens in Palette	Pen Number	Color
2 (“NP 2;”)	0	White
	1	Black
4 (“NP 4;”)	0	White
	1	Black
	2	Red
	3	Green
8 (“NP 8;”)	0	White
	1	Black
	2	Red
	3	Green
	4	Yellow
	5	Blue
	6	Magenta
	7	Cyan

For black and white printers that accept color descriptions and palettes, pen 0 defaults to white; all remaining pen colors default to “equivalent gray levels.” An equivalent gray level means that lighter colors (for example, yellow) are converted to light gray shades, and darker colors (for example, purple) are converted to dark gray shades. The mapping algorithm is device-dependent. However, equivalent gray levels represent solid colors, and any white pixels within them are not subject to transparency mode (TR).

Note

In the “shading” Fill Type command (FT10;), the shading levels are mapped between white (0% shading) and the equivalent gray level for the currently selected pen (100% shading). In the “HP-GL/2 user-defined” Fill Type command (FT11;), each pixel in the RF pattern is rounded to white or black based on the equivalent gray level of the pen number for that pixel. This rounding should use a low enough white/black threshold so that yellow will round to black.

For a black and white device, pen 0 defaults to white; all remaining pen colors default to black.

This command is ignored if the current palette was created by the Simple Color command (Ec*r#U). An IN command defaults pen colors as indicated in the previous table.

NP (Number of Pens)

The NP command resizes the palette after the IN or $E_C^*v\#W$ commands.

NP [*n*;

or

NP[:]

Parameter	Format	Functional Range	Parameter Default
n	clamped integer	2 to 32768	device-dependent*

* The default palette size for the HP color printers is 8.

- **n** — the parameter n denotes the size of the HP-GL/2 palette, where n is a power of two. If n is not a power of two, the next larger power of two is used. The palette is an array of virtual pens, each having an associated color value and an associated width. Pen colors are defined in terms of RGB components using the PC command. Widths are established using the PW and WU commands. A pen is selected with the SP command.

The maximum value for n is device-dependent, but is greater than or equal to the number of distinct colors the printer is able to produce. If n is larger than that maximum, the maximum-sized palette is allocated. If $n < 2$, error 3 is set and the command is ignored.

The “NP;” command defaults the palette size. Receipt of this command does not default pen colors and/or widths for existing pen values. For example, if the palette size is initially 8 and is decreased to 4, pen colors and widths for the new palette are retained from the colors and widths of the first 4 pens of the old palette. If the palette size is increased from 8 to 16, the colors and widths for the first 8 pens remain the same, and the colors and widths of the remaining pens are defaulted. The pens are defaulted in accordance to how the palette was created (either CID or Simple Color palettes).

If the currently selected pen is outside the range of the new palette size, the SP command modulo function is applied to obtain a pen number which will index into the new palette; this clears the current residue (the unused portion of a pattern) and terminates any sequence of continuous vectors. For more information, see the descriptions of the Line Attribute (LA) and Line Type (LT) commands in the *PCL 5 Printer Language Technical Reference Manual*.

The number of pens is defaulted by an IN command.

This command is ignored if the current palette was created by the Simple Color command ($E_C^*r\#U$) or $E_C E$.

CR (Color Range)

The CR command sets the range for specifying relative color data.

Note

This command is only supported by the HP Color LaserJet, Color LaserJet 5, 5M, and DeskJet printers. It is not supported by the HP Color LaserJet 4500 or 8500 printers.

CR [*b_ref_red, w_ref_red, b_ref_grn, w_ref_grn, b_ref_blue, w_ref_blue;*]

Parameter	Format	Functional Range	Parameter Default
b_ref (red, green, blue)	clamped real	-32768 to 32768	0
w_ref (red, green, blue)	clamped real	-32768 to 32768	255

Relative color is in reference to a range defined by a black and white reference value for each primary (red, green, and blue). For example, if the white reference is set as red=63, green=63, blue=63, and the black references are set as red = 0, green = 0, and blue = 0, then white = 63, 63, 63; black = 0, 0, 0; and medium blue = 0, 0, 31. However, if the white reference is set as red = 63, green = 127, blue = 31 and the black reference is set as red = 4, green = 0, and blue = 0, then white = 63, 127, 31; black = 4, 0, 0; and medium blue = 4, 0, 15.

The first two parameters set the black and white references (respectively) for red; the second pair sets the green references, and the final pair the blue reference values. If the black reference value for any primary is equal to the white reference value for the same primary, the command is ignored.

The default for red, green, and blue “black references” is 0; the default for red, green and blue “white references” is 255.

This command is defaulted by the “CR;” and IN commands.

Execution of this command causes current pen colors to be remapped to the new range, so that current palette colors remain unchanged.

PP (Pixel Placement)

When printing, the printer places pixels at the intersection of the squares of a theoretical, device-dependent grid covering the printable area on a page. When the sides of two HP-GL/2 polygons touch each other, the pixels along the border may be printed twice or not at all—depending on the logical operation in effect. For example, if a source rectangle consisting of all 1's is XORed with a destination consisting of all 1's, a white rectangle is printed. If another source rectangle is placed on the page touching the first rectangle, the two rectangles are white-filled except at their common border: that is, $(1 \wedge 1) \wedge 1 = 1$.

To correct this situation, two models of pixel placement are used: grid intersection and grid centered. The grid intersection model is the default: pixels are rendered on the intersections of the device-dependent grid covering the page. In the grid-centered model, the number of rows and columns are each reduced by one, and pixels are placed in the center of the squares, rather than at the intersections.

The following example illustrates the concepts of the two models. Assume a rectangle extends from coordinate position (1,1) to position (3,4). As shown below, for the same coordinates, the grid-centered model produces a rectangle that is one dot row thinner and one dot row shorter than the grid intersection model. Thus, when two or more polygons on a page share a common border, grid centering (value=1) can be turned on.

Since PCL printers print only at the intersections of the grid, the actual implementation of the grid-centered model is also shown in the following illustration.

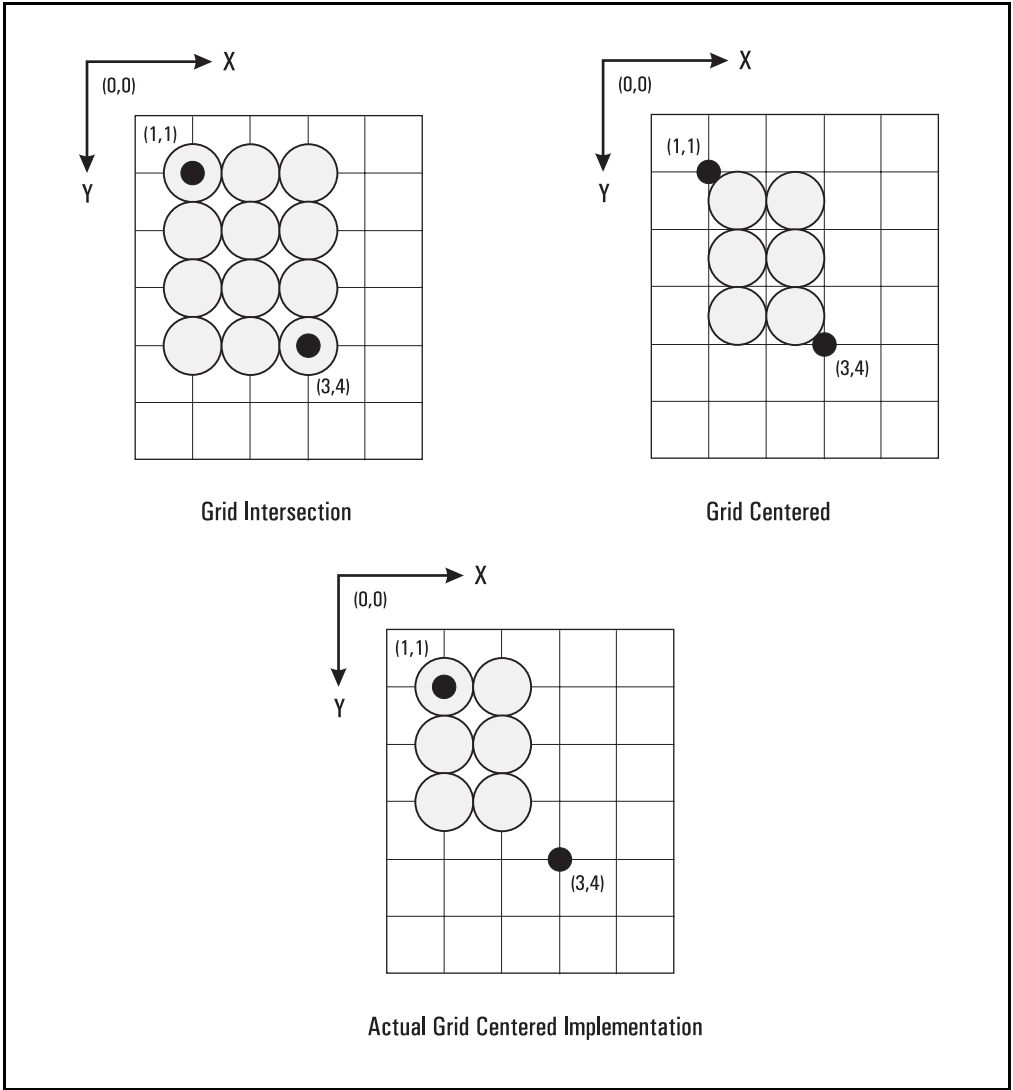

Figure 7-1 Pixel Placement

PP, Pixel Placement Command

The Pixel Placement (PP) command controls how pixels are placed on the layout grid during polygon fills. The two pixel placement modes are grid intersection or grid centered.

PP [*mode*;]

Parameter	Format	Functional Range	Parameter Default
mode	clamped integer	0 or 1	0 (grid intersection)

- **mode**

- 0 grid intersection; device draws pixels centered at grid intersections (see Figure 7-1).
- 1 grid centered; device draws pixels centered inside the boxes created by the grid (see Figure 7-1).

When the printer is set to grid-centered mode (mode 1), portions of a polygon that are zero height or zero width are not rendered. When the printer is set to grid intersection mode (mode 0), portions that are zero height or width are rendered as lines. Portions that are both zero height and width are rendered as dots.

This command affects only HP-GL/2 polygons; it has no effect on characters, rules, or raster graphics. This command can be invoked multiple times during a page; it has no effect except to switch the model used for imaging.

This command is the HP-GL/2 version of the PCL Pixel Placement command. Whatever mode is selected, using the HP-GL/2 PP command also applies to PCL operation. Likewise the PCL Pixel Placement command also affects HP-GL/2 pixel placement.

Note

Microsoft Windows fills polygons based on the grid-centered method.

This command determines how pixels will be placed for both HP-GL/2 and PCL operation.

The PP command is not defaulted by an IN command.

A Color Printing Overview (Color LaserJet, 5, 5M, DeskJet)

Introduction

This appendix provides an overview of the way color is used in the HP Color LaserJet, Color LaserJet 5, 5M, DeskJet 1200C, and DeskJet 1600C printers. It previews the remaining appendices, which describe the specific details of Hewlett-Packard color printing.

Note

The features described in these appendices are a superset of those supported by the HP Color LaserJet, Color LaserJet 5, 5M and DeskJet printers. Some features are supported on one or more printers, but not necessarily on all of them. See the *PCL 5 Comparison Guide* for specific feature support for each printer.

Processing a color document involves specifying a palette or palettes, and then using the colors within the current palette to print. For non-raster printing, items such as text, rules, and vectors are simply printed in the currently active color, which is specified using the Foreground Color command or Select Pen command if in HP-GL/2. For raster printing, the color of each pixel is specified as either a direct color specification, or as an index into the palette, depending on the pixel encoding mode.

The PCL Print Model determines how color is applied to the page. The printed result can vary in background and texture depending on the source transparency mode, pattern transparency mode, and selected logical operation (ROP). Besides the pre-defined shading and patterns, users can define new monochrome or multicolor patterns.

When printing color pages, a user can choose one of several color modes, depending on the desired results. Each color mode has a palette associated with it. *Simple Color Mode* provides a palette of fully saturated colors whose colors are similar to those of a plotter's pen colors. The palette is nonprogrammable, and is intended for simple printing of items such as bar and pie charts. For applications requiring different or more specific colors, the printer offers the *PCL Imaging* and *HP-GL/2 Imaging* Modes. The palette colors in these two modes can be modified to provide the desired result.

When choosing color for a particular application, the Color LaserJet printer provides *device-dependent* and *device-independent* color (the DeskJet 1200C and 1600C support only device-dependent color). *Device-independent* color provides accurate color matching based on an absolute color standard. It is preferred when users want a precise color to match the output from another device or to match the color on an existing page.

Besides providing device-independent color for precise color matching, the HP printers can modify color to compensate for various characteristics. The Color LaserJet printer supports the following methods of modifying color (the DeskJet 1200C and 1600C printers support halftone algorithms and gamma correction, but not color lookup tables or the Viewing Illuminant command).

- *Halftone render algorithms* determine how colors are rendered using the printers available colors. Halftone algorithms can be used to change apparent resolution, change the texture of images, reduce the number of colors, and change a color image to monochrome.
- *Color lookup tables* can remap colors to compensate for various differences in input data, such as unwanted color casts caused by unbalanced photographic light sources.
- *Gamma correction* provides a way to adjust for color differences in display monitors so that the display more closely matches the printed output.
- Since the appearance of colors changes under different viewing light sources, the *Viewing Illuminant* command allows the application to modify output color based on the light source used to view the printed page.

Color Concepts

This section describes some of the concepts and terminology used in this chapter, such as palettes, raster vs. non-raster color, device-independent vs. device-dependent color, black and white references, color selection, pixel encoding, and color modes.

Palettes

A palette is a collection of colors that are selected by their index numbers. You can create your own palette or choose from one of several fixed palettes. Although only one palette is active at any time, all palettes are assigned ID numbers and can be stored in the printer for later selection using the ID number. They can be deleted when desired. Palettes can also be saved (pushed) to a stack and later retrieved (popped) when needed.

Raster Mode

Raster mode is entered explicitly by the Start Raster command ($E_C*r\#A$) or implicitly by a Transfer Raster command ($E_C*b\#V$, $E_C*b\#W$). Raster mode is exited explicitly by an End Raster command (E_C*rC) or implicitly by a non-raster command.

Raster Color vs. Non-Raster Color

Palettes are used differently depending on whether the printer is in raster mode.

- In non-raster mode, the palette is always used for color selection. The color of text or patterns is specified using the Foreground Color command ($E_C*v\#S$).
- In raster mode, the palette is only used for indexed color selection; it is not used for direct color selection. (Indexed and direct color selection are explained later in this section.)

Device-Dependent vs. Device-Independent Color

Device-dependent color spaces are relative to the device's ability to produce specific colors. For example, if red is specified in a device-dependent color space, two different printers will combine the same amounts of cyan, magenta, yellow, and black toner to produce the color, but the results will be different because of the different properties of the toner.

Device-independent color is specified absolutely, in a color coordinate system that is independent of any device. For example, if red is specified in a device-independent color space, two printers will always produce the same result, even though they may need to combine different amounts of cyan, magenta, yellow, and black toner. Printers that produce device-independent color are calibrated to precise color standards.

Black and White References

Device-dependent color specifications are based upon an arbitrary range of values for each primary color component. The range endpoints for each color component are called black and white references for that component. Colors relative to these predefined limits are derived by specifying the amount of each component.

For the Device RGB color space, the maximum limit is called the white reference and the minimum limit is called the black reference. Regardless of the number chosen, the white reference represents the maximum value of a primary color that a device can produce, and the black reference represents the minimum value of that primary color. For example, if 100 is chosen as the white reference for red in the RGB color model, it represents the reddest red the device can produce. If 10 were chosen instead, then 10 would represent the same red.

Example:

Assuming the white and black references are set as follows:

Scenario 1

White Reference	Black Reference
red = 63	red = 0
green = 63	green = 0
blue = 63	blue = 0

Scenario 2

White Reference	Black Reference
red = 63	red = 4
green = 127	green = 0
blue = 31	blue = 0

Using these reference values, 50% blue for scenario 1 is 31, and 50% blue for scenario 2 is 15.

Color Selection

The HP color printers offer two methods for selecting colors:

- Indexed selection
- Direct selection

In indexed selection, colors are chosen using their palette index numbers. For non-raster mode, the palette index number is specified using the Foreground Color command. In raster mode, the data bit combination for each pixel forms an index number. The example below shows how the index numbers for an 8-color palette are specified:

Three-bit combinations:	0 1 0 1 0 1 0 1
	0 0 1 1 0 0 1 1
	0 0 0 0 1 1 1 1
Palette index number:	0 1 2 3 4 5 6 7

The number of colors in the palette dictates the number of bits per pixel of raster data required to specify an index number. For example, to specify 256 colors you need to send 8 bits of raster data per pixel ($2^8 = 256$).

In direct selection, colors are specified using the proportions of their primary components. For example, using a 24-bit-per-pixel representation, the color specified by (0xff, 0xf0, 0x00) for red, green, and blue would print a slightly red-tinted yellow. A palette is not used for direct selection.

Pixel Encoding

Colors are encoded in a row of raster data using either *plane* or *pixel* format. In planar format, all the pixels in a row are partially specified by one plane (bit) before the next plane is sent. In pixel format, each pixel is fully specified before sending the next pixel.

Encoding by Plane

Planar encoding uses successive data planes, each providing one bit for each pixel in a row. Each plane builds upon the preceding planes until the pixels in a row are fully defined. A pixel is not fully defined until it has received all the planes for that row.

The planes in a row form index numbers that define a pixel by selecting a palette entry. For example, an 8-entry palette requires 3 planes ($2^3 = 8$). The underlined bits below compose the index of the color of the third pixel in the first row.

$E_C * b \# V$	row 1	plane 1 (red)	b1	b1	<u>b1</u>	b1	b1	b1	...
$E_C * b \# V$		plane 2 (grn)	b2	b2	<u>b2</u>	b2	b2	b2	...
$E_C * b \# W$		plane 3 (blue)	b3	b3	<u>b3</u>	b3	b3	b3	...
$E_C * b \# V$	row 2	plane 1 (red)	b1	b1	b1	b1	b1	b1	...

Encoding by Pixel

When encoding by pixel, each pixel is fully specified before any bits are sent for the next pixel. For example, if four bits are needed to define a pixel, then every group of four bits in the data stream defines a pixel. The underlined ($c_4 \dots c_1$) group below defines the second pixel in the first row.

```
EC*b#W   row 1   b4 b3 b2 b1 c4 c3 c2 c1 . . .
EC*b#W   row 2   b4 b3 b2 b1 . . .
```

The table below shows the four PCL options for selecting colors and encoding color raster data.

	Planar Encoding	Pixel Encoding
Indexed Selection	Indexed planar	Indexed pixel
Direct Selection	Direct planar	Direct pixel

Color Modes

There are four PCL 5 color modes:

- Black and White mode
- Simple Color mode
- PCL Imaging mode
- HP-GL/2 Imaging mode

All four modes create a palette. The palettes used in the Black and White mode and Simple Color mode are not modifiable. You can, however, modify the palettes in the PCL Imaging and HP-GL/2 Imaging modes.

You can use more than one mode on the same page. For example, you could enter the Simple Color mode to print a headline and a bar chart, PCL Imaging mode to print a raster photograph, and Black and White mode to print some body text. Each mode is described in more detail in Appendix B, "Using Color Modes."

Device-Dependent Color Spaces

The following PCL commands can alter color processing for device-dependent color spaces:

- Rendering Algorithm ($E_C^*t\#J$)
- Gamma Correction ($E_C^*t\#I$)
- Color Lookup Tables ($E_C^*l\#W$)
- Configure Image Data ($E_C^*v\#W$)
- Simple Color ($E_C^*r\#U$)
- Monochrome Print Mode ($E_C\&b\#M$)

Color lookup tables or gamma correction (which are mutually exclusive) can modify the mapping of input to output.

Device-Independent Color Spaces

The following PCL commands can alter color processing for device-independent color spaces:

- Rendering Algorithm ($E_C^*t\#J$)
- Gamma Correction ($E_C^*t\#I$)
- Color Lookup Tables ($E_C^*l\#W$)
- Configure Image Data ($E_C^*v\#W$)
- Viewing Illuminant ($E_C^*i\#W$)
- Monochrome Print Mode ($E_C\&b\#M$)

Device-independent color spaces are supported under the following conditions:

- 1 The Configure Image Data command ($E_C^*v\#W$) configures the current palette and specifies a device-independent color space.
- 2 The Render Algorithm command ($E_C^*t\#J$) is set to one of the following algorithms (see “Halftone Render Algorithms” in Appendix D for details):
 - Continuous tone detail (E_C^*t0J , E_C^*t16J)
 - Continuous tone smooth (E_C^*t15J , E_C^*t17J)
 - Continuous tone basic (E_C^*t18J , E_C^*t19J)
 - Device best dither (E_C^*t3J , E_C^*t5J)
 - Error Diffusion (E_C^*t4J , E_C^*t6J)

- Cluster Ordered Dither (E_C*t7J, E_C*t8J)
- Ordered Dither (E_C*t11J, E_C*t12J)

Color processing reverts to device-dependent processing if the render algorithm is changed from one of the above. This is because extensive device characterization is necessary to achieve device-independence—calibration must be based on known parameters that affect the device's color gamut. Render algorithms such as Snap to Primaries (E_C*t1J), Snap Black to White and Colors to Black (E_C*t2J), or User-Defined Halftone (E_C*t9J) either limit the number of colors available, or are undefined to the extent that their performance is not as precise. These algorithms, therefore, produce device-dependent results. Device-independent color is again generated if the render algorithm changes to one of the 5 listed above and the color space has not changed.

Device-Independent Color

The PCL language characterizes color as either device-dependent or device-independent. Both categories encompass many color spaces, each with unique characteristics.

Device-Dependent Color

Device-dependent color is relative to the device's inherent characteristics. For example, the colors produced by plotters are relative to the color of the installed plotter pens. Pen color varies considerably, especially as pens wear out, changing the color of the output. Likewise, for monitor screens, the red, green, and blue screen phosphors determine the colors produced. Fully saturated colors can vary greatly between screens. For printers, the color produced on a page depends on the printer's subtractive inks or toner (cyan, magenta, yellow, and black).

When using device-dependent color, devices receiving relative color specifications for the same color frequently do not produce the same color. For example, a monitor's saturated red may be different than a plotter's. In short, the same color page may appear considerably different on different devices.

The HP color printers provide device-dependent color specified using either the Device RGB or CMY color spaces.

Device-Independent Color

In contrast with device-dependent color, device-independent color is based on an absolute color standard—the tristimulus values of human vision. The device, whether a printer or otherwise, is calibrated to match an independent color specification. The color specification is translated in such a way that the resultant color is independent of the device. Examples of color spaces based on absolute standards include Kodak Photo YCC, CIE $L^*a^*b^*$, YUV, and the proposed YCrCb. Each is a transform from tristimulus CIE XYZ space.

With proper calibration, any device can provide a transform from device-independent color space to the device's own color space, producing output from different devices that have the same color appearance. For example, if a monitor's parameters are known (gamma, gain, chromaticity coordinates for each primary, and the white point), the monitor's RGB pixel information can be transformed into device-independent color.

The Color LaserJet printers provide device-independent color specified using either the CIE L*a*b*, Colorimetric RGB, or Luminance-Chrominance color spaces.

HP Color LaserJet 5 and 5M printers also provide device independent color specified using either the CIE L*a*b*, Colorimetric RGB or Luminance-Chrominance color spaces. However, HP Color LaserJet 5 and 5M printers are somewhat restricted in what they provide. Details of this can be found in Appendix D.

Color Matching

When attempting to match color produced by different devices, it is important to know the difference between true color matching and appearance matching.

Proper device calibration can achieve true color matching, so that a side-by-side comparison of a printed page with the monitor on which the page was designed will show an exact match. However, true color matching is only satisfactory when using the monitor as a viewing reference. Viewed away from the screen, the printed page may appear flat and unsaturated because printers and monitors have different dynamic ranges. For example, black on the screen appears gray when compared to printed black, which is unacceptable if the intent is pure black. Likewise, the white produced on a monitor screen appears yellow or blue when compared to a white sheet of paper. True color matching would require that gray be printed in the black areas and colored dots be printed in the white areas.

Color Appearance Matching

Color appearance matching goes beyond true color matching by including adjustments for the dynamic ranges of the devices, so the user's intent is maintained. For example, the white areas of a page shown on a monitor display screen would be printed as white on a printed page because the user specified white, even though the screen cannot duplicate a white that truly matches white paper. Although the printed color does not exactly match screen color, color appearance does match, which is what users usually want. To maximize user satisfaction, the PCL language uses appearance matching when rendering device-independent color.

Color Lookup Tables

Color lookup tables, which provide additional control of the printed output, are transformations that map input data into a new output color range based upon point-by-point conversions.

Overhead transparencies provide one example of a good use for color lookup tables. Let's say a page is printed on plain paper and it matches the user's expectations. When printing the same document on overhead transparency film, the resulting image looks unsaturated and flat. To compensate, the user can send a color lookup table to increase color saturation without changing composition (for example, using the CIE $L^*a^*b^*$ color space to increase the a^* and b^* parameters in equal amounts).

Color lookup tables can also be used to adjust data from a Kodak CD-ROM, which uses the Photo YCC device-independent color space. The gamma correction table is complex and cannot be described by the traditional logarithmic expression. However, since the data can be mapped into new data values via tables, the user can provide a gamma correction table that essentially describes the complex correction factors.

Color lookup tables can be used to "neutral-balance" an image. For example, an underwater photograph produces a severe bluish cast when printed. The user can eliminate that cast from the image by providing a color lookup table that subtracts some color portion from each of the primaries.

Illumination Models

Illumination sources have different spectral distributions, causing colors to appear differently under one light source compared to another. For example, printed colors that look normal in natural sunlight shift in hue when viewed under fluorescent and tungsten lighting. The PCL language allows the user to compensate for the differences in viewing illumination using the Viewing Illuminant command. It allows the user to select different illuminations.

Processing Color Documents

To process a color page, PCL provides ways of specifying and modifying color so that the printed result appears as the user desires. This section provides a conceptual overview of the process.

Non-Raster Color vs. Raster Color

All color portions of a page consist of either:

- Page Marking Primitives (non-raster data)
- Color Raster Data

Page Marking Primitives

Non-raster data consists of HP-GL/2 and PCL page marking primitives such as glyphs, rules, polygons, circles, and vectors. Page marking primitives contain no color information about the image. They merely mark the page with attributes assigned to the current working environment (for example, colors, patterns, logical operation modes, etc.). Page marking primitives act as stencils through which color “paint” is poured, forming a homogeneous pattern.

Page marking primitives print in the currently specified color, which is specified using the Foreground Color command. For example, if you specify the color blue using the Foreground Color command, and then send some text to the printer, the text will be printed blue.

Color Raster Data

Unlike page marking primitives, each pixel of a color raster image contains color information. A color raster pixel may be defined by either:

- Palette Entry Indices
- Direct Color Specifications

User-defined color patterns are a form of color raster, but each pixel of a user-defined color pattern can be defined only by palette entry indices, not by direct color specifications.

Color Processing Functions

Given these two color uses, page marking primitives and color raster data, color processing must:

- Convert color attributes to an internal representation that can be poured through the page marking stencil onto the destination via some logical operation.
- Convert multiple-bit-per-pixel color raster to an internal representation that can be merged into the destination via some logical operation.

Color processing must have access to the following state variables, which indicate the form and attributes by which the two color groups are generated.

- Halftone (rendering algorithm)
- RGB gamma correction
- Device-dependent color lookup tables for each of the three primaries

Appendix B describes in more detail how color raster data is specified.

B Using Color Modes (Color LaserJet, 5, 5M, DeskJet)

This appendix describes how color commands were supported on the following printers:

- HP Color LaserJet, Color LaserJet 5 / 5M
- HP DeskJet 1200C and 1600C

Since then, the PCL 5 color command set has been simplified as described in Chapter 1. Appendices A through D and Chapters 5 through 7 describe the color commands as they were supported for these printers.

Introduction

The PCL printer language has four color modes:

- Black-and-White
- Simple Color
- PCL Imaging
- HP-GL/2 Imaging

PCL allows you to use any mode or combination of modes to accomplish your printing objectives most efficiently.

All four of the color modes create a palette. The palette for each mode is discussed in the section describing that mode, and also in Appendix C (“Using Palettes”).

Black-and-White Mode (Default)

Black-and-White Mode is the default color mode. PCL devices power up in this mode and revert back to it whenever the printer receives an E_cE reset. Black-and-White mode is also selectable using the Simple Color command (E_c*r1U). This mode creates an unmodifiable, default 2-pen palette, with white at index 0 and black at index 1 (compatible with existing monochrome PCL 5 printers).

Simple Color Mode

Simple Color Mode, entered by the Simple Color command ($E_c*r#U$), creates a fixed-size, fixed-color, unmodifiable palette. Depending on the value field, $E_c*r#U$ can create a 2-pen Black-and-White palette, an 8-pen RGB palette, or an 8-pen CMY palette. When using the Simple Color mode, the pixel encoding mode is always indexed planar.

PCL Imaging Mode

PCL Imaging Mode, enabled by the Configure Image Data command ($E_c*v#W$), allows a maximum of 24 bits per pixel for color specification. Therefore, more colors (produced by halftoning) may be specified than are obtainable in Simple Color Mode. In the PCL Imaging Mode, pixel encoding mode, bits per pixel, bits per primary, white/black references, and the color palette are all programmable.

HP-GL/2 Imaging Mode

In HP-GL/2, the Initialize (IN) command starts color imaging and performs the following:

- Sets the pixel encoding mode to index by plane.
- Sets bits per index to 3.
- Creates an 8-pen palette that is reprogrammable in either PCL or HP-GL/2 contexts (see Appendix C, "Using Palettes," for more information).

Although default HP-GL/2 palettes are different than default PCL palettes, an HP-GL/2 palette is modifiable in either PCL or HP-GL/2 (using the Assign Color Index [$E_c*v\#I$] or Pen Color [PC] commands, respectively). Likewise, a PCL palette created by the Configure Image Data command ($E_c*v\#W$) is modifiable in both PCL and HP-GL/2 using the same commands.

The active palette is always transferred between HP-GL/2 and PCL contexts. Since only one palette at a time can be active, a new palette created in either context overwrites the current palette.

Simple Color Mode

The Simple Color command ($E_C^*r\#U$) specifies color selection from a fixed palette. RGB or CMY raster data must be sent by plane ($E_C^*b\#V$) as well as by row ($E_C^*b\#W$). The last plane in each row is sent using the $E_C^*b\#W$ command; all other planes are sent using the $E_C^*b\#V$ command. In Simple Color mode, the pixel encoding mode is always indexed planar.

Simple Color Command

The Simple Color command creates a fixed-size palette, whose color specification cannot be modified.

$E_C^*r\#U$

- #** = -3 - 3 planes, device CMY palette
- 1 - Single plane K (Black) palette
- 3 - 3 planes, device RGB palette

Default = 1

Range = -3, 1, 3

The absolute value of the value field specifies the number of planes per row of raster data to be sent. The number of entries in the new palette is 2^n , with index values 0 to $2^n - 1$. For example, a 3-plane palette has 8 entries, with index numbers 0 to 7.

This command destroys the active palette and creates a new palette, which becomes the active palette. When the Simple Color mode is active, PCL and HP-GL/2 commands that modify the palette are locked out (NP, PC, $E_C^*v\#A$, $E_C^*v\#B$, $E_C^*v\#C$, $E_C^*v\#I$). When a Simple Color palette is popped from the stack ($E_C^*p\#P$), it cannot be modified, and the pixel encoding mode reverts to indexed planar.

- A value field of **1** creates a 2-entry Black-and-White default palette.
- A value field of **3** creates an 8-entry Device RGB palette (compatible with a PCL Imaging Mode palette, but not an HP-GL/2 default (IN) palette).
- A value field of **-3** creates an 8-entry palette in Device CMY color space.

The Simple Color palettes are shown below:

Single Plane (value = 1)

Index	Color
0	White
1	Black

3-Plane RGB (value = 3)

Index	Color
0	Black
1	Red
2	Green
3	Yellow
4	Blue
5	Magenta
6	Cyan
7	White

3-Plane CMY (value = -3)

Index	Color
0	White
1	Cyan
2	Magenta
3	Blue
4	Yellow
5	Green
6	Red
7	Black

PCL Imaging Mode

The PCL Imaging mode, entered using the Configure Image Data (CID) command ($E_C*v\#W$), creates a variable-sized programmable palette. It provides halftoning in the printer, with multiple color spaces, pixel encoding modes, and reprogrammable palettes.

Configure Image Data (CID) Command

The CID command provides configuration information for creating palettes and transmitting raster data. The CID command performs the following:

- Designates the color space for the default palette
- Designates the size of the palette to be created
- Provides data for transforming color-space-specific values into device-specific values
- Provides data for transforming device-dependent data (monitor RGB) to device-independent (Colorimetric RGB)
- Designates the format of raster data and how primary components are combined to yield the raster representation

$E_C*v\#W$ [*binary data*]

= Number of data bytes

Default = NA

Range = Short form: 6 bytes
Long form: >6 bytes

Invalid configurations of the CID command are ignored and the data discarded. Any signs in the value field are ignored.

The data fields in this command must contain byte-aligned binary data, not ASCII data.

This command has two forms: the six-byte short form described below, and the long form consisting of these six bytes, plus additional information specific to the color space.

Common 6-Byte Header

The short and long forms of the CID command use a common 6-byte header, regardless of which color space is specified. The header data fields, whose meaning may vary according to the color spaces, are present in all color space specifications. The short form and long form of the CID command are explained separately in the following pages.

Byte	15 (MSB)	8	7	0 (LSB)	Byte
0	Color space (UBYTE)		Pixel encoding mode (UBYTE)		1
2	Bits/index (UBYTE)		Bits/primary #1 (UBYTE)		3
4	Bits/primary #2 (UBYTE)		Bits/primary #3 (UBYTE)		5

Byte 0 (Color Space)

This byte specifies the color space. The range of values is 0 through 4. All other values are ignored.

Byte Value	Color Space
0	Device RGB (default)
1	Device CMY
2	Colorimetric RGB Spaces
3	CIE L*a*b*
4	Luminance-Chrominance Spaces

Note

Colorimetric RGB color spaces are based on the 1931 standard 2-degree observer and specified by CIE xy chromaticity coordinates. They use the standard D6500 viewing illuminant and a 45-degree illumination model with a 0-degree collector geometry for reflective data.

CIE L*a*b* is the CIE 1976 Uniform Color Space based on the 1931 standard 2-degree observer, and using a 45-degree illumination model with a 0-degree collector geometry for reflective data. The viewing illuminant is the standard D6500 illuminant.

Luminance-Chrominance spaces are a 3x3 linear transformation from Colorimetric RGB. Like CIE L*a*b*, achromatic data is contained in one channel and chromatic data shares the other two channels.

Note

HP Color LaserJet 5 and 5M printers parse and discard the CID command when Colorimetric RGB spaces are specified. Rather than creating a Colorimetric RGB palette, a device RGB palette is created, but it is populated with the default color of the Colorimetric RGB palette. In addition, the ScreenMatch color table is selected to give the impression of Colorimetric RGB behavior while working in a device-dependent space

Byte 1 (Pixel Encoding Mode)

Byte number 1 designates the format in which raster data is to be transmitted and interpreted. The range of this value field is 0 to 3. All other values for this field are ignored.

Byte Value	Pixel Encoding Mode	Restrictions
0	Indexed by Plane (default)	Bits/index must be 1, 2, 3, 4, 5, 6, 7, or 8
1	Indexed by Pixel	Bits/index must be 1, 2, 4, or 8
2	Direct by Plane	1 bit per primary (RGB or CMY only)
3	Direct by Pixel	8 bits per primary (All Color Spaces)

You need one plane or one bit/pixel for each power of two colors in the palette. For example, a 256-color palette requires 8 planes or 8 bits/pixel ($2^8 = 256$).

Note

Direct pixel encoding modes (2, 3) cannot be compressed using raster compression modes 1 or 2. Planar pixel encoding modes (0, 2) cannot be compressed using raster compression mode 5.

MODE 0: INDEXED BY PLANE

In mode 0 (default), successive planes of data are sent for each raster row. A plane contains one bit for each pixel in a row. A pixel is not fully defined until it has received all the planes for that row. The planes in a row form index numbers that define a pixel by selecting a palette entry. Assuming 3 bits per index, the underlined column of bits below is the palette index for pixel 3 of row 1 (i1 is lsb; i3 is msb). Note that the Transfer Raster Data by Plane command ($E_C*b#V$) is used for all planes except the last plane of each row, which uses the Transfer Raster Data by Row command ($E_C*b#W$).

$E_C*b#V$	row 1	plane 1	i1	i1	<u>i1</u>	i1	i1
$E_C*b#V$		plane 2	i2	i2	<u>i2</u>	i2	i2
$E_C*b#W$		plane 3	i3	i3	<u>i3</u>	i3	i3
$E_C*b#V$	row 2	plane 1	i1	i1	i1	i1	i1

Example:

`^C*v6W 00 00 03 08 08 08` # Binary data for CID represented in hex. Sets color space to RGB, pixel encoding mode to 0, palette size to 8 (3 planes), last 3 bytes ignored.

`^C*r1A` # Start raster.

`^C*b1V10110000 . . .` # Transfer plane 1 (the first bit for each pixel in the first row). Combining each bit with its corresponding bit in the other planes forms the palette index number for that pixel.

`^C*b1V01110000 . . .` # Transfer plane 2 (the second bit for each pixel in the row).

`^C*b1W10101000 . . .` # Transfer plane 3 (the third bit for each pixel in the row) and move to the next row. Note that the `^C*b#W` command is used to send the last plane of each row.

MODE 1: INDEXED BY PIXEL

In mode 1, each pixel in a row is fully specified before any bits are sent for the next pixel. The bits for each pixel form a palette index number. Assuming 4 bits per index, the underlined block below is the palette index for pixel 2 of row 1 (i1 is lsb).

<code>^C*b#W</code>	row 1	i4	i3	i2	i1	<u>i4 i3 i2 i1</u>	. . .			
<code>^C*b#W</code>	row 2	i4	i3	i2	i1	i4	i3	i2	i1	. . .
<code>^C*b#W</code>	row 3	i4	i3	i2	i1	i4	i3	i2	i1	. . .

Example:

`EC*v6W 00 01 04 04 04 04` # Binary data for CID represented in hexadecimal. Sets color space to RGB, pixel encoding mode to 1, palette size to 16 (4 bits to address palette index). Last 3 bytes ignored.

`EC*r1A` # Start raster.

`EC*b1W45` # Most significant nibble selects palette index 4 for the first pixel. Second pixel is set to index 5. Move to the next row.

`EC*b1W6A` # First pixel is index 6, second pixel is index 10. Move to the next row.

`EC*b1W03` # First pixel is index 0, second pixel is index 3. Move to the next row.

MODE 2: DIRECT BY PLANE

In mode 2, the color raster data for each row is downloaded by sequential planes, but the pixel color is directly specified, rather than forming an index into the palette. The underlined block below defines the actual primaries for pixel 3 of row 1.

<code>E_C*b#V</code>	row 1	red plane	r	r	<u>r</u>	r	r
<code>E_C*b#V</code>		green plane	g	g	<u>g</u>	g	g
<code>E_C*b#W</code>		blue plane	b	b	<u>b</u>	b	b
<code>E_C*b#V</code>	row 2	red plane	r	r	r	r	r

Example:

```
E_C*v6W 00 02 01 01 01 01 # Binary data for CID represented
                                in hex. Sets color space to RGB,
                                pixel encoding mode to 2. Palette
                                size is ignored because this is a
                                direct selection, not indexed. Last
                                3 bytes are always 1 for this
                                mode.

E_C*r1A                          # Start raster.

E_C*b1V10110000 . . .          # Transfer plane for primary color
                                1. Each bit turns on or off the red
                                primary for the pixel defined by
                                the corresponding bits in each
                                plane.

E_C*b1V01110000 . . .          # Transfer plane for primary color
                                2. Each bit turns on or off the
                                green primary of the pixel.

E_C*b1W10101000 . . .          # Transfer plane for primary color
                                3 and move to the next row. Each
                                bit turns on or off the blue primary
                                of the pixel.
```

MODE 3: DIRECT BY PIXEL

In mode 3, the color raster data is downloaded pixel by pixel (as in mode 1), but each pixel directly specifies each color component (as in mode 2). Assuming Device RGB space with 8 bits per primary, the underlined block below defines the actual color primaries for pixel 1 of row 2.

```
E_C*b#W   row 1   r7-r0   g7-g0   b7-b0 . . .
E_C*b#W   row 2   r7-r0   g7-g0   b7-b0 . . .
E_C*b#W   row 3   r7-r0   g7-g0   b7-b0 . . .
```

Example:

```
EC*v6W 00 03 00 08 08 08 # Binary data for CID
                                # represented in hex. Sets color
                                # space to RGB, pixel encoding
                                # mode to 3. Palette size is
                                # ignored. Send 8 bits to address
                                # each primary value for a pixel.

EC*r1A # Start raster.

EC*b3W 45 06 30 # Each byte sets a primary
                                # value for the first pixel and
                                # moves to the next row (45
                                # specifies the red, 06 the green,
                                # and 30 the blue component
                                # value of that pixel).
```

Byte 2 (Number of Bits per Index)

In all pixel encoding modes, this byte sets the size of the palette to 2^n , where n is the number of bits per index.

- In pixel encoding modes 0 and 1 (indexed), where raster data is interpreted as indices into a palette, this value specifies the number of bits required to access all palette entries.
- In pixel encoding modes 2 and 3 (direct), this value determines palette size, but has no effect on the specification of raster data.

Byte 3 (Number of Bits for Primary #1)

This byte is ignored in pixel encoding modes 0 and 1, but affects the black and white references in device-dependent color spaces. In Device RGB, the black reference for primary #1 is set to 0 and the white reference is set to $2^n - 1$, where n is the number of bits for primary #1. These references are reversed in Device CMY color space.

- *In pixel encoding mode 2*, this byte is ignored except in Device RGB and Device CMY color space, where it designates the number of data bits needed to specify primary #1, as well as the number of data planes to be sent for primary #1.
- *In pixel encoding mode 3*, this byte designates the number of data bits needed to specify primary #1.

A value of 0 defaults the black and white reference values for primary #1 according to the color space.

Byte 4 (Number of Bits for Primary #2)

This byte is ignored in pixel encoding modes 0 and 1, but affects the black and white references in device-dependent color spaces. In Device RGB, the black reference for primary #2 is set to 0, and the white reference is set to $2^n - 1$, where n is the number of bits for primary #2. These references are reversed in Device CMY color space.

- *In pixel encoding mode 2*, this byte is ignored except in Device RGB and Device CMY color spaces, where it designates the number of data bits needed to specify primary #2, as well as the number of data planes to be sent for primary #2.
- *In pixel encoding mode 3*, this byte designates the number of data bits needed to specify primary #2.

A value of 0 defaults the black and white reference values for primary #2 according to the color space.

Byte 5 (Number of Bits for Primary #3)

This byte is ignored in pixel encoding modes 0 and 1, but affects the black and white references in device-dependent color spaces. In Device RGB, the black reference for primary #3 is set to 0, and the white reference is set $2^n - 1$, where n is the number of bits for primary #3. These references are reversed in Device CMY space.

- *In pixel encoding mode 2*, this byte is ignored except in Device RGB and Device CMY color space, where it designates the number of data bits needed to specify primary #3, as well as the number of data planes to be sent for primary #3.
- *In pixel encoding mode 3*, this byte designates the number of data bits needed to specify primary #3.

A value of 0 defaults the black and white reference values for primary #3 according to the color space.

Short Form of CID Command (Configure Image Data)

The Short Form of the CID command involves sending just the common 6-byte header. By changing the value of byte 0 (color space), the short form can specify the following five color spaces:

- Device RGB $E_C^*v6W[0x00, \dots]$
- Device CMY $E_C^*v6W[0x01, \dots]$
- CIE L*a*b* $E_C^*v6W[0x03, \dots]$

The following data ranges are allowed in CIE L*a*b*. Hue is preserved when out-of-range data is clipped.

$L^* = 0.0$ to 100.0

$a^* = -100.0$ to 100.0

$b^* = -100.0$ to 100.0

Note

CIE L*a*b* color space support is at HP Color LaserJet level for HP Color LaserJet 5 and 5M printers.

- Colorimetric RGB (SMPTE RGB) $E_C^*v6W[0x02, \dots]$

Non-linear SMPTE RGB with a 2.2 gamma and 1.0 gain is the default Colorimetric RGB color space. The short form allows the following ranges:

$R = 0.0$ to 1.0

$G = 0.0$ to 1.0

$B = 0.0$ to 1.0

Note

HP Color LaserJet 5 and 5M printers bypass the Colorimetric RGB process. In place of it, a device-dependent RGB process is substituted with a Screen Match color table.

- Luminance-Chrominance (YUV) $E_C^*v6W[0x04, \dots]$

YUV, which is a linear transformation from SMPTE RGB, is the default Luminance-Chrominance color space. The short form allows the following ranges:

$$Y = 0.0 \text{ to } 1.0$$

$$U = -0.89 \text{ to } 0.89$$

$$V = -0.70 \text{ to } 0.70$$

Note

Luminance-Chrominance color space support is at HP Color LaserJet level for HP Color LaserJet 5 and 5M printers.

Data Range Scaling

White and black references define the encoding range for device-dependent color spaces. However, device-independent color spaces require input data pre-scaled to the range 0 to 255. For example, to use the short form for the default YUV color space, the input data must have the following ranges:

$$Y = 0.0 \text{ to } 1.0$$

$$U = -0.89 \text{ to } 0.89$$

$$V = -0.70 \text{ to } 0.70$$

The user must linearly scale ($y = mx + b$) the input data to the range 0 – 255:

$$Y = 0 \text{ (0.0) to } 255 \text{ (1.0)}$$

$$U = 0 \text{ (-0.89) to } 255 \text{ (0.89)}$$

$$V = 0 \text{ (-0.70) to } 255 \text{ (0.70)}$$

Long Form of CID Command (Configure Image Data)

In addition to the short form, there is also a long form of the CID command for each color space. In device-independent color spaces, the long form can specify primaries other than the defaults provided by the short form. For example, a Sony Trinitron RGB primary base can be selected for Colorimetric RGB instead of the default non-linear SMPTE RGB primaries.

Device RGB (Long Form)

The long form for the Device RGB color space (value field 18) provides explicit entry of black and white references (range is -32767 to 32767). Black and white references are used in the direct pixel encoding modes (2,3) to set relative limits for raster data; they are also used when specifying the primary components of new palette entries ($E_C*v\#A$, $E_C*v\#B$, $E_C*v\#C$). Black and white references have no effect on CID default palette colors. The reference values are specified as 16-bit signed integers (sint16).

Note

The short form for the Device RGB color space defaults each primary's black reference to 0 and the white reference to 2^n-1 , where n is the number of bits for that primary.

Byte	15 (msb)	8	7	(lsb) 0	Byte
0	Color space		Pixel encoding mode		1
2	Bits per index		Bits per primary #1		3
4	Bits per primary #2		Bits per primary #3		5
6	White reference for primary #1 (sint 16)				7
8	White reference for primary #2 (sint 16)				9
10	White reference for primary #3 (sint 16)				11
12	Black reference for primary #1 (sint16)				13
14	Black reference for primary #2 (sint16)				15
16	Black reference for primary #3 (sint16)				17

Device CMY (Long Form)

The long form for the Device CMY color space (value field is 18) provides explicit entry of black and white references (range is -32767 to 32767). Black and white references are used in the direct pixel encoding modes (2,3) to set relative limits for raster data; they are also used when specifying the primary components of new palette entries ($E_C*v\#A$, $E_C*v\#B$, $E_C*v\#C$). Black and white references have no effect on the default CID palette colors. The reference values are specified as 16-bit signed integers (sint16).

Note

The short form for the Device CMY color space defaults each primary's white reference to 0 and black reference to 2^n-1 , where n is the number of bits for that primary.

Byte	15 (msb)	8	7	(lsb) 0	Byte
0	Color space		Pixel encoding mode		1
2	Bits per index		Bits per primary #1		3
4	Bits per primary #2		Bits per primary #3		5
6	White reference for primary #1 (sint16)				7
8	White reference for primary #2 (sint16)				9
10	White reference for primary #3 (sint16)				11
12	Black reference for primary #1 (sint16)				13
14	Black reference for primary #2 (sint16)				15
16	Black reference for primary #3 (sint16)				17

CIE L*a*b* (Long Form)

The long form for the CIE L*a*b* color space allows a larger data range than the short form defaults:

L^* = 0.0 to 120.0 (greater than the short form by 20.0)

a^* = -159.0 to 128.0 (less than the short form by -32.0 and greater than the short form by 28.0)

b^* = -120.0 to 80.0 (less than the short form by 20.0)

Note

Although the data ranges may extend beyond the default data ranges specified in the short form of the CID command, the printer will clip the data to the short form data ranges.

Maximum and minimum values are specified for each primary color. Floating point data must be linearly scaled ($y = mx + b$) to the range 0 – 255.

Since a^* and b^* have no theoretical limits, $L^*a^*b^*$ data may be sent outside CID constraints. Then data is clipped to preserve hue and compressed to the device's printable gamut.

Note

CIE $L^*a^*b^*$ color space support is at HP Color LaserJet level for HP Color LaserJet 5 and 5M printers.

The white point is based on the standard D6500 illuminant.

Byte	15 (msb)	8	7	(lsb) 0	Byte
0	Color space		Pixel encoding mode		1
2	Bits per index		Bits per primary #1		3
4	Bits per primary #2		Bits per primary #3		5
6	Minimum L^* value (most significant word)*				7
8	Minimum L^* value (least significant word)*				9
10	Maximum L^* value (msw)				11
12	Maximum L^* value (lsw)				13
14	Minimum a^* value (msw)				15
16	Minimum a^* value (lsw)				17
18	Maximum a^* value (msw)				19
20	Maximum a^* value (lsw)				21
22	Minimum b^* value (msw)				23
24	Minimum b^* value (lsw)				25
26	Maximum b^* value (msw)				27
28	Maximum b^* value (lsw)				29

FLOATING POINT FORMAT

The following format is used for device-independent color floating point specifications:

31	30	23	22	0
Sign	Exponent		Fractional Portion	

The above single-precision, 32-bit floating point specification is fully compliant with the IEEE Floating Point Formats.

Colorimetric RGB (Long Form)

The long form for Colorimetric RGB allows specifications other than the default non-linear SMPTE RGB with a 2.2 gamma and 1.0 gain. Each RGB primary and the white point is specified in the CID data field by chromaticity coordinates (CIE xy). The tristimulus luminance Y value of the white point is assumed to be 100% and is therefore not specified. For color spaces that are linear transformations from CIE XYZ tristimulus coordinates, gamma and gain are set to 1.0; otherwise they are set appropriately. Colorimetric RGB spaces can be used for any monitor having primaries specified as CIE xy chromaticity coordinates with white point, such as the Sony Trinitron or Hitachi Color Monitor.

Byte	15 (msb)	8	7	(lsb) 0	Byte
0	Color space		Pixel encoding mode		1
2	Bits per Index		Bits per primary #1		3
4	Bits per primary #2		Bits per primary #3		5
6	x Chromaticity for red primary (msw)				7
8	x Chromaticity for red primary (lsw)				9
10	y Chromaticity for red primary (msw)				11
12	y Chromaticity for red primary (lsw)				13
14	x Chromaticity for green primary (msw)				15
16	x Chromaticity for green primary (lsw)				17
18	y Chromaticity for green primary (msw)				19
20	y Chromaticity for green primary (lsw)				21

Byte	15 (msb)	8	7	(lsb) 0	Byte
22	x Chromaticity for blue primary (msw)				23
24	x Chromaticity for blue primary (lsw)				25
26	y Chromaticity for blue primary (msw)				27
28	y Chromaticity for blue primary (lsw)				29
30	x Chromaticity for white point (msw)				31
32	x Chromaticity for white point (lsw)				33
34	y Chromaticity for white point (msw)				35
36	y Chromaticity for white point (lsw)				37
38	Gamma for red primary (msw)				39
40	Gamma for red primary (lsw)				41
42	Gain for red primary (msw)				43
44	Gain for red primary (lsw)				45
46	Gamma for green primary (msw)				47
48	Gamma for green primary (lsw)				49
50	Gain for green primary (msw)				51
52	Gain for green primary (lsw)				53
54	Gamma for blue primary (msw)				55
56	Gamma for blue primary (lsw)				57
58	Gain for blue primary (msw)				59
60	Gain for blue primary (lsw)				61
62	Minimum red value (msw)				63
64	Minimum red value (lsw)				65
66	Maximum red value (msw)				67
68	Maximum red value (lsw)				69
70	Minimum green value (msw)				71
72	Minimum green value (lsw)				73
74	Maximum green value (msw)				75

Byte	15 (msb)	8	7	(lsb) 0	Byte
76	Maximum green value (lsw)				77
78	Minimum blue value (msw)				79
80	Minimum blue value (lsw)				81
82	Maximum blue value (msw)				83
84	Maximum blue value (lsw)				85

Note

HP Color LaserJet 5 and 5M printers bypass the Colorimetric RGB process. In place of it, a device-dependent RGB process is substituted with a Screen Match color table.

Luminance-Chrominance (Long Form)

The long form for Luminance-Chrominance allows color spaces other than the default YUV, such as Kodak Photo YCC, the proposed JPEG and TIFF 6.0 YCrCb standard, YES, and YIQ. These Luminance-Chrominance color spaces are derived from the Colorimetric RGB space using a 3x3 transformation matrix. The tristimulus luminance *y* value of the white point is assumed to be 100% and is therefore not specified.

Byte	15 (msb)	8	7	(lsb) 0	Byte
0	Color space		Pixel encoding mode		1
2	Bits per index		Bits per primary #1		3
4	Bits per primary #2		Bits per primary #3		5
6	Encoding for primary #1 R (msw)				7
8	Encoding for primary #1 R (lsw)				9
10	Encoding for primary #1 G (msw)				11
12	Encoding for primary #1 G (lsw)				13
14	Encoding for primary #1 B (msw)				15
16	Encoding for primary #1 B (lsw)				17
18	Encoding for primary #2 R (msw)				19
20	Encoding for primary #2 R (lsw)				21

Byte	15 (msb)	8	7	(lsb) 0	Byte
22	Encoding for primary #2 G (msw)				23
24	Encoding for primary #2 G (lsw)				25
26	Encoding for primary #2 B (msw)				27
28	Encoding for primary #2 B (lsw)				29
30	Encoding for primary #3 R (msw)				31
32	Encoding for primary #3 R (lsw)				33
34	Encoding for primary #3G (msw)				35
36	Encoding for primary #3 G (lsw)				37
38	Encoding for primary #3 B (msw)				39
40	Encoding for primary #3 B (lsw)				41
42	Minimum primary #1 value (msw)				43
44	Minimum primary #1 value (lsw)				45
46	Maximum primary #1 value (msw)				47
48	Maximum primary #1 value (lsw)				49
50	Minimum primary #2 value (msw)				51
52	Minimum primary #2 value (lsw)				53
54	Maximum primary #2 value (msw)				55
56	Maximum primary #2 value (lsw)				57
58	Minimum primary #3 value (msw)				59
60	Minimum primary #3 value (lsw)				61
62	Maximum primary #3 value (msw)				63
64	Maximum primary #3 value (lsw)				65
66	x Chromaticity for red primary (msw)				67
68	x Chromaticity for red primary (lsw)				69
70	y Chromaticity for red primary (msw)				71
72	y Chromaticity for red primary (lsw)				73
74	x Chromaticity for green primary (msw)				75

Byte	15 (msb)	8	7	(lsb) 0	Byte
76	x Chromaticity for green primary (lsw)				77
78	y Chromaticity for green primary (msw)				79
80	y Chromaticity for green primary (lsw)				81
82	x Chromaticity for blue primary (msw)				83
84	x Chromaticity for blue primary (lsw)				85
86	y Chromaticity for blue primary (msw)				87
88	y Chromaticity for blue primary (lsw)				89
90	x Chromaticity for white point (msw)				91
92	x Chromaticity for white point (lsw)				93
94	y Chromaticity for white point (msw)				95
96	y Chromaticity for white point (lsw)				97
98	Gamma for red primary (msw)				99
100	Gamma for red primary (lsw)				101
102	Gain for red primary (msw)				103
104	Gain for red primary (lsw)				105
106	Gamma for green primary (msw)				107
108	Gamma for green primary (lsw)				109
110	Gain for green primary (msw)				111
112	Gain for green primary (lsw)				113
114	Gamma for blue primary (msw)				115
116	Gamma for blue primary (lsw)				117
118	Gain for blue primary (msw)				119
120	Gain for blue primary (lsw)				121

Note

CIE L*a*b* color space support is at HP Color LaserJet level for HP Color LaserJet 5 and 5M printers.

Examples Using the CID Command

The following examples illustrate using the CID command's short and long forms for each color space. For clarity, data is shown as ASCII, rather than binary and the CID command ($\text{E}_c^*v\#W$) is shown as "CID". The following format is used:

CID (data , data , . . .)

Device RGB or Device CMY

SHORT FORM

CID(0,1,8,8,8,8)	Device RGB, 8 bits/pixel indexed
CID(1,1,8,8,8,8)	Device CMY, 8 bits/pixel indexed

Example:

The short form CID command, as a C function, can look like this:

```
short_cid(Color_mode, Pixel_mode, BitsperIndex,  
          BitsperColor_1, BitsperColor_2, BitsperColor_3)  
{  
    int Color_mode, Pixel_mode, BitsperIndex,  
        BitsperColor_1, BitsperColor_2, BitsperColor_3;  
  
    printf("\033*v6W%c%c%c%c%c%c", Color_mode,  
          Pixel_mode, BitsperIndex, BitsperColor_1,  
          BitsperColor_2, BitsperColor_3);  
}
```

LONG FORM

CID(0,1,8,8,8,8,	Device RGB, 8 bits/pixel indexed
0,0,0	White reference
100,100,100)	Black reference

CIE L*a*b*

SHORT FORM

CID(3,3,0,8,8,8) L*a*b*, direct 8 bits/primary

LONG FORM

CID(3,3,0,8,8,8, L*a*b*, direct 8 bits/primary
0.0, 100.0, L* data encoding
-100.0, 100.0, a* data encoding
-100.0, 100.0) b* data encoding

Non-Linear SMPTE RGB, 2.2 Gamma, 1.0 Gain

SHORT FORM

CID(2,3,0,8,8,8) RGB, direct 8 bits/primary

LONG FORM

CID(2,3,0,8,8,8, RGB, direct 8 bits/primary
0.64, 0.34, |
0.31, 0.60, | Chromaticity coordinates
0.16, 0.07, | for RGB & White Point
0.3127, 0.3290, |
2.2, 1.0, *
2.2, 1.0, * Gamma and gain for RGB
2.2, 1.0, *
0.0, 1.0, |
0.0, 1.0, | Data range encoding
0.0, 1.0) |

Non-Linear Sony Trinitron

SHORT FORM

Not Applicable

LONG FORM

CID(2,3,0,8,8,8	RGB, direct 8 bits/primary
0.62, 0.34,	
0.30, 0.58,	Chromaticity coordinates
0.15, 0.09,	for RGB
0.2800, 0.2933,	White Point
2.3, 1.19,	*
2.3, 1.19,	* Gamma and gain for RGB
2.3, 1.19,	*
0.0, 255.0,	
0.0, 255.0,	Data range encoding
0.0, 255.0)	

YUV Chrominance-Luminance Color Space

SHORT FORM

CID(4,3,0,8,8,8) YUV, direct 8 bits/primary

YUV Chrominance-Luminance with Sony Trinitron

LONG FORM

CID(2,3,0,8,8,8	YUV, direct 8 bits/primary
0.30,0.59,0.11,	
-0.30,0.59,0.89,	3x3 YUV matrix
0.70,-0.59,-0.11,	
0.0,255.0	*
-227.0,227.0,	* Data encoding
-179.0,179.0	*
0.62,0.34,	
0.30,0.58,	Chromaticity
0.15,0.09,	coordinates
0.2800, 0.2933,	chromaticity white point
2.3,1.19,	*
2.3,1.19,	* Gamma and
2.3,1.19)	* gain for RGB

HP-GL/2 Imaging Mode

The HP-GL/2 Imaging Mode provides a way of using vector commands in printing documents. Although the default PCL and HP-GL/2 palettes are not the same, when transferring from PCL to HP-GL/2, active palette information does stay the same. You can switch between PCL and HP-GL/2 and use the same palette, and you can also modify palettes using either PCL or HP-GL/2.

Compared to monochrome printers, the Color LaserJet and DeskJet 1200C color printers have some commands that are modified for use with color printers. Chapter 7 describes the new or modified HP-GL/2 commands.

If you are not familiar with using HP-GL/2, see the *PCL 5 Printer Language Technical Reference Manual*. It provides a detailed explanation of using HP-GL/2.

C Using Palettes (Color LaserJet, 5, 5M, DeskJet)

Introduction

A palette is a collection of color specifications selected using index numbers. The figure below illustrates a palette. Each palette entry associates an index number with three primary color components. For HP-GL/2 purposes only, a pen width is also associated with each palette entry.

Color Table				HP-GL/2 Pen Width
	Primary 1	Primary 2	Primary 3	
0				
1				
2				
3				
4				
5				
6				
7				
8				
9				
n		•		•
(max. 255)		•		•
		•		•

Pixel Encoding Mode	Bits per Primary
• Pixel Color Selection	• Primary 1
By Index or Direct	• Primary 2
• Pixel Color Transfer	• Primary 3
By Row or By Plane	

In non-raster mode, the current palette contains all the colors available to the printer. In raster mode, indexed color selection uses the palette, but direct selection does not.

Default palettes are created by all the PCL color modes (Black and White, Simple Color, PCL Imaging, and HP-GL/2 Imaging). The active palette may be modified when in the PCL Imaging or HP-GL/2 imaging modes, but not when in the Simple Color or Black and White modes. When switching between PCL 5 and HP-GL/2 contexts, the active palette is automatically transferred.

Multiple palettes can exist in the system via the Palette ID and Palette Stack mechanism. However, only one palette at a time can be active. A palette created in the PCL context remains active and unchanged when switching to the HP-GL/2 context, and a palette created in the HP-GL/2 context remains active and unchanged when switching to the PCL context. Performing a reset or entering PJI overwrites the active palette with the default black and white palette.

Whenever a new palette is created, the currently or previously active palette is destroyed. A new palette is created by power-on and also by the following commands:

- PCL Reset (E_cE)
- Simple Color ($E_c^*r\#U$)
- Configure Image Data ($E_c^*v\#W$)
- HP-GL/2 Initialize (IN)

The active palette can be saved by pushing it onto the palette stack with the Push/Pop Palette command ($E_c^*p\#P$). Popping a palette from the stack destroys the active palette—the popped palette becomes the active palette.

Saving the Palette

The current palette is destroyed when a new palette is created. The Push/Pop Palette command ($E_C^*p\#P$) can save (push) the current palette and then restore (pop) it.

Push/Pop Palette Command

This command pushes or pops the palette from the palette stack.

$E_C^*p\#P$

- # = 0 - Push (save) palette
- 1 - Pop (restore) palette

Default = 0

Range = 0, 1 (invalid values are ignored)

A value of 0 (E_C^*p0P) pushes a copy of the active palette onto the palette stack. When a palette is pushed, the active palette is not affected.

A value of 1 (E_C^*p1P) pops the most recently pushed palette and destroys the active palette; the popped palette becomes the active palette. As with any stack, the last item pushed is the first item popped.

Pushing a palette saves the following parameters:

- Color definitions for each palette entry
- Pen widths (for HP-GL/2 use)
- Color space specification
- Black and white references
- Number of bits per index
- Pixel encoding mode
- Number of bits per primary
- Gamma correction
- Viewing illuminant
- Color lookup tables
- Render algorithm
- Downloaded dither matrix

Pushing a palette does not save the following parameters.

- Foreground color
- Color components: 1st, 2nd, and 3rd
- Finish mode
- Monochrome print mode

The palette stack depth is limited by printer memory. Attempts to push a palette with insufficient memory cause an out-of-memory error. Attempts to pop from an empty stack are ignored.

Macros can push and pop palettes. A palette that was popped in an *executed* macro remains in effect at the end of the macro (this is not true for “called” or “overlaid” macros).

PCL reset commands ($\text{E}c\text{E}$) and exits to PJL cause the printer to empty the palette stack and overwrite the active palette with a non-programmable black and white palette. The HP-GL/2 commands IN and DF have no effect on the palette stack, but they do destroy the active palette and replace it with the default HP-GL/2 palette.

Palette Management by ID

All palettes have a unique ID (identification number). The default black and white palette created on power-up or E_{cE} has an ID of 0.

Palette management by ID lets applications have multiple palettes. As shown below, multiple palettes can exist in two areas: the palette stack and the palette store. The stack holds palettes that are pushed via a Push/Pop Palette command; the store holds palettes having palette IDs.

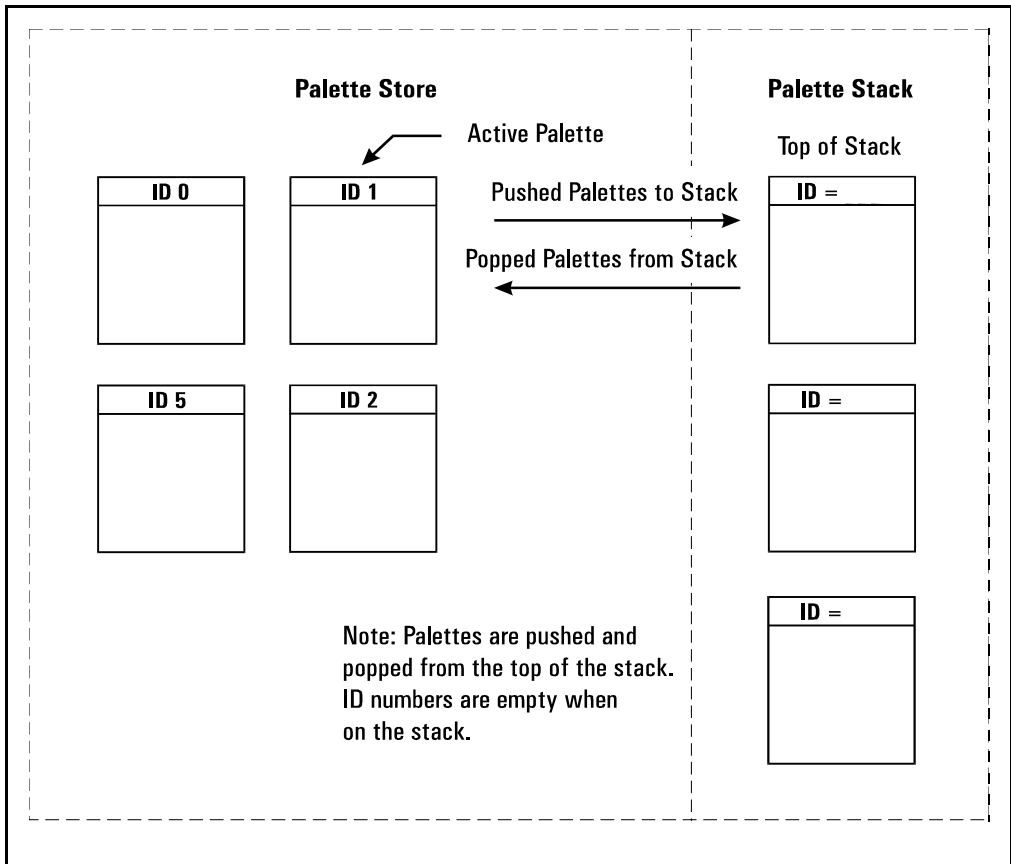

Palettes on the stack may not be selected by ID, since only a copy of a palette is pushed onto the stack; the original palette and ID remain in the palette store. A palette popped from the stack goes into the palette store, becomes the new active palette, and assumes the ID of the previously active palette, which is overwritten. Only one palette at a time may be active.

Management by ID allows applications to tag data, have multiple raster configurations, and have palettes for different color spaces—all without reconfiguring the active palette. For example, one palette can be created for PCL text, one for HP-GL/2 primitives, one for simple raster, and one for 24-bit raster. The application can then switch between palettes according to what is being sent to the printer.

Selecting a new active palette changes the PCL graphics state. Besides color entries, a palette also contains the graphics state at the time the bitmap representation of the palette colors was created. This guarantees color reproduction integrity by insuring that the same color specification triplet always produces the same bitmap representation.

As described below, the Select Palette ($E_C&p\#S$), Palette Control ($E_C&p\#C$), and Palette Control ID ($E_C&p\#I$) commands implement the three basic operations of management by ID.

- Selection of the active palette
- Deletion of palettes
- Copying of palettes

Select Palette Command

The Select Palette command selects a new active palette by specifying an ID number. The previously active palette is unchanged.

$E_C&p\#S$

= Palette ID number

Default = 0

Range = 0 to 32767 (command is ignored for out- of-range values)

This command activates the designated palette in the palette store. The command is ignored if the specified ID matches the active palette's ID, or if no palette with that ID exists. The designated ID is saved as the palette select ID in the current modified print environment.

This command can be used to de-select the active palette and select as the new active palette a palette created by the Palette Control command ($\text{E}_C\&p\#C$). For example, to copy the active palette to an ID of 44 and select the new palette to use or modify, send $\text{E}_C\&p44i6c44S$.

When a palette creation command is received such as Configure Image Data ($\text{E}_C*v\#W$), Simple Color ($\text{E}_C*r\#U$), or an HP-GL/2 IN, the created palette overwrites the active palette and is assigned the current palette select ID, which is unchanged.

A palette popped from the stack overwrites the active palette, and is assigned the current palette select ID, which is unchanged.

E_CE resets the palette select ID value to 0 and deletes all palettes in the palette stack and palette store, including the active palette which is replaced by a default PCL fixed black and white palette with a palette select ID value of 0.

Macros affect the palette select ID value as follows:

- Calling or Overlaying a macro—saves the ID value and a copy of the active palette. Upon macro exit, the restored palette again becomes the active palette with the restored ID. An existing palette with this ID is deleted.
- Executing a macro—does not save the ID value or the active palette; changes remain in effect.

Palette Control ID

The Palette Control ID command specifies the ID number to be used by the Palette Control Command.

$\text{E}_c\&p\#l$

= Palette ID number

Default = 0

Range = 0 to 32767 (command is ignored for out- of-range values)

The ID number specified by this command is saved as the palette control ID in the current modified print environment and is used by the Palette Control command ($\text{E}_c\&p\#C$).

E_cE or power-up resets the palette control ID to 0, which is then the default black and white palette ID.

Macros affect the palette control ID value as follows:

- Calling a macro—saves the value and restores the value at exit.
- Executing a macro—does not save the value; changes remain in effect at exit.
- Overlaying a macro—copies the value before resetting to 0, and restores at exit.

Palette Control

The Palette Control command provides a mechanism for marking and deletion of palettes.

$\text{E}_C\&p\#C$

- # = 0 - Delete all palettes except those in the stack (active palette deleted)
- 1 - Delete all palettes in the stack (active palette is not affected)
- 2 - Delete palette (specified by Palette Control ID)
- 6 - Copy active palette to ID specified by Palette Control ID

Default = 0

Range = 0, 1, 2, 6 (command is ignored for unsupported values)

- A value of **0** deletes all palettes except those on the palette stack. The active palette is replaced by the default black and white palette (ID 0). The palette control ID is not used.
- A value of **1** clears the palette stack. The active palette is unaffected, and the palette control ID is not used.
- A value of **2** deletes the palette with the specified palette control ID if it exists; otherwise the command is ignored. For example, to delete palette 53, send $\text{E}_C\&p53i2C$. If the active palette's ID is specified the active palette is replaced by the default black and white palette. This option does not change the palette control ID value.

Note

When the active palette is replaced by the default black and white palette, the graphics state associated with the previous palette is also replaced.

- A value of **6** creates a copy of the active palette. The copy receives the ID specified by the last Palette Control ID command. For example, to copy the active palette to a palette with an ID of 14, send $\text{E}_C\&p14i6C$. The copied palette overwrites any palette that already has an ID equal to the palette control ID. The copied palette does not become the active palette. The command is ignored if a palette is to be copied to its own ID.

The Palette Control command provides a way of managing system memory by deleting palettes in either the stack or store that are no longer in use.

Palette Control that is exercised during macros can have significant impact on palettes that exist within the system. Deleting all palettes, or those on the stack, or the current palette, or all those except on the stack can have adverse effects when the macro is exited. The adverse effect could be the deletion of the desired palette, and replacement with a black and white non-programmable palette.

Simple Color Palettes

The Simple Color command ($E_C^*r\#U$) provides a quick way to select colors from a fixed, non-programmable palette.

The Simple Color command overwrites the current palette with one of the fixed palettes below. When the Simple Color command is in effect, the PCL and HP-GL/2 commands that modify a palette entry (NP, CR, PC, $E_C^*v\#A$, $E_C^*v\#B$, $E_C^*v\#C$, $E_C^*v\#I$, $E_C^*t\#I$) are locked out. A popped simple color palette cannot be modified and the pixel encoding mode reverts to "index by plane". Only the IN or the CID ($E_C^*v\#W$) commands can create a modifiable palette.

As shown below, a value field of 1 (E_C^*r1U) creates a black and white palette. A value of 3 creates an 8-pen palette in Device RGB color space. A value of -3 creates an 8-pen palette in Device CMY color space. All of these Simple Color palettes are fixed and non-programmable.

Single Plane (value = 1)

Index	Color
0	White
1	Black

3-Plane RGB (value = 3)

Index	Color
0	Black
1	Red
2	Green
3	Yellow
4	Blue
5	Magenta
6	Cyan
7	White

3-Plane CMY (value = -3)

Index	Color
0	White
1	Cyan
2	Magenta
3	Blue
4	Yellow
5	Green
6	Red
7	Black

CID Color Palettes

The Configure Image Data command, explained in detail in Appendix B, creates a palette based upon the parameters in its data field. CID-created palettes are programmable: any entry can be reassigned a different color using PCL commands ($E_C*v\#A$, $E_C*v\#B$, $E_C*v\#C$, $E_C*v\#I$) or HP-GL/2 commands (CR, PC, NP). Default palettes vary by color space.

Device RGB Palettes

The black and white references specified by the CID command have no effect on the default palettes below. However, when a CID palette entry is reprogrammed with a different color, the black and white references are used to specify the primary components of the new color.

Bits/Index = 1

Index	Color
0	White
1	Black

Bits/Index = 2

Index	Color
0	Black
1	Red
2	Green
3	White

Bits/Index = 3 through 8

Index	Color
0	Black
1	Red
2	Green
3	Yellow
4	Blue
5	Magenta
6	Cyan
7	White
n > 7	Black

Device CMY and Device-Independent Palettes

A CID command specifying either a device-independent color space or the Device CMY color space creates the same default palettes. This is because device-independent colors are transformed into the printer's native space, Device CMY.

Bits/Index = 1

Index	Color
0	White
1	Black

Bits/Index = 2

Index	Color
0	White
1	Cyan
2	Magenta
3	Black

Bits/Index = 3 through 8

Index	Color
0	White
1	Cyan
2	Magenta
3	Blue
4	Yellow
5	Green
6	Red
7	Black
n > 7	Black

HP-GL/2 Palettes

Regardless of the color space, a default PCL palette is always different than a default HP-GL/2 palette. The following table shows the default palettes established in HP-GL/2. Like a default CID palette, a default HP-GL/2 palette can be modified in either PCL or HP-GL/2 contexts using the following commands:

PCL

- Color Components 1, 2, and 3 ($E_C^*v\#A$, $E_C^*v\#B$, $E_C^*v\#C$)
- Assign Color Index ($E_C^*v\#I$)

HP-GL/2

- Number of Pens (NP)
- Pen Color Assignment (PC)
- Set Relative Color Range (CR)

Note

The IN command always establishes the 8-pen palette.

Two Pens

Pen Number	Color
0	White
1	Black

Four Pens

Pen Number	Color
0	White
1	Black
2	Red
3	Green

Eight Pens

Pen Number	Color
0	White
1	Black
2	Red
3	Green
4	Yellow
5	Blue
6	Magenta
7	Cyan
n > 7	Black

Foreground Color

All PCL marking entities utilize “foreground” color, which is selected from the current palette using the Foreground Color command ($E_C*v\#S$). Foreground color interacts with raster color depending on the print model commands in effect.

Foreground Color Command

The Foreground Color command sets the foreground color to the specified index of the current palette.

$E_C*v\#S$

= Index number into current palette

Default = 0

Range = 0 to $2^{(\text{current palette size})} - 1$

Specified values that are out-of-range of the current palette are mapped into a new index as follows:

$\text{Index} = \text{Specified foreground index modulo palette size}$

For example, specifying a foreground color index of 10 when the current palette size is 8 maps 10 modulo 8, which is equal to 2. If the current palette was created under HP-GL/2, the index is mapped according to the HP-GL/2 mapping function.

Foreground color affects the following PCL page marking primitives:

- Text characters (they change to the foreground color, including underlining)
- Solid or monochrome patterned rectangular area fills (rules)
- Monochrome patterns (except HP-GL/2)
- Raster images

The following are not affected:

- User-defined color patterns (format 1 download patterns)
- HP-GL/2 marking primitives (HP-GL/2 uses “selected pen”, but ignores foreground color)

Note

Foreground color interacts with color raster images. In the printer, all color raster is resolved into three binary raster planes of CMY. Foreground color is applied to these planes, modifying the color image. For no interaction, set foreground color to black when sending color raster images.

After a foreground color is selected, changing any of the following will not change foreground color until a new Foreground Color command ($E_c^*v\#S$) is issued:

- Active Palette
- Configure Image Data (CID) command
- Render Algorithm
- User Defined Dither Matrix
- Gamma Correction
- Color Lookup Tables
- Viewing Illuminant

As an exception, Monochrome Print Mode ($E_c\&b\#M$) immediately maps foreground color to its equivalent gray. Similarly, deselection of Monochrome Print Mode immediately returns foreground color to its color equivalent.

Programming Color Palettes

Except for the default black and white palette or the Simple Color palettes ($E_C^*r\#U$), palette entries can be modified. The three primary components of a color are specified and the resulting color is assigned to the palette entry indicated by $E_C^*v\#I$.

In the explanation below, the term “component” refers to the color space primary colors. For example, if the current color space is CIE $L^*a^*b^*$, component 1 indicates CIE L^* , component 2 indicates CIE a^* , and component 3 indicates CIE b^* .

Color Component One

This command specifies the first primary of the palette entry designated by the Assign Color Index command ($E_C^*v\#I$).

$E_C^*v\#A$

= First Component

Default = 0

Range = -32767.0000 to 32767.0000 (up to 4 decimal places; command is ignored for invalid configurations)

The Assign Color Index command actually applies this value and then resets it to 0.

Color Component Two

This command specifies the second primary of the palette entry designated by the Assign Color Index command.

$E_C^*v\#B$

= Second Component

Default = 0

Range = -32767.0000 to 32767.0000 (up to 4 decimal places; command is ignored for invalid configurations)

The Assign Color Index command actually applies this value and then resets it to 0.

Color Component Three

This command specifies the third primary of the palette entry designated by the Assign Color Index command.

$E_C*v\#C$

= Third Component

Default = 0

Range = -32767.0000 to 32767.0000 (up to 4 decimal places; command is ignored for invalid configurations)

The Assign Color Index command actually applies this value and then resets it to 0.

Assign Color Index

This command assigns the three current color components to the specified palette index number.

$E_C*v\#I$

= Index Number

Default = 0

Range = 0 to $2^n - 1$, where n is the number of bits per index (no assignment for out-of-range values)

This command resets the color components to 0 after assignment. If the specified index number is greater than the palette size, no index assignment is made, but the three color components are set to 0.

D Modifying Output Color (Color LaserJet, 5, 5M, DeskJet)

Introduction

The previous appendices of this manual have been concerned with giving an overview of the color printing process, choosing color modes, and using palettes. This portion of the manual explains how color can be modified to produce a desired result, from using halftone render algorithms to change the way color is rendered, to compensating for the yellow cast caused by a tungsten light source in a photograph. The HP color printers can modify colors using the following means:

- *Halftone render algorithms* provide a way to modify images based on a dither cell concept. The algorithm chosen determines how specified colors are “rendered” as dots on the printed page.
- *Color lookup tables* can remap palette colors to compensate for unwanted color characteristics of input data. For example, if a scanned photograph had a reddish cast, a color lookup table could be used to make the printed image look as if it were taken under a more balanced light source.
- *Gamma correction* provides a way to adjust for color differences in display monitors.
- The *Viewing Illuminant* command allows you to vary the xy chromaticity coordinates for the light source under which you will be viewing a printed piece. For example, if the printed document is to be viewed under a tungsten light, the command modifies colors so that they have the correct appearance when illuminated by a tungsten light bulb.
- The *Monochrome Print Mode* command converts each color to its grayscale equivalent for faster draft printing.

- The *Driver Configuration* command provides a way for a driver to calibrate the output by adjusting color lightness, saturation, and color map information.

All of these methods of modifying output color are explained in the following sections.

Halftone Render Algorithms

The HP color printers have the capability of applying different halftone render algorithms to achieve the desired output on the printed image. Render algorithms allow you to change the characteristics of the image by changing the way pixels are rendered. Each halftone render algorithm produces a different affect on the output, varying the texture and color appearance of the printed image.

To choose the type of rendering to be used, use the Render Algorithm command, described below. This command allows you to choose one of the existing rendering algorithms or to choose a user-defined pattern created with the Download Dither Matrix command.

Render Algorithm Command

The Render Algorithm command selects the algorithm to be used for rendering page marking entities on a given page.

$E_C^*t\#J$

- # = 0 - Continuous tone (device best dither)
- 1 - Snap to primaries
- 2 - Snap black to white, color to black
- 3 - Device best dither
- 4 - Error diffusion
- 5 - Monochrome device best dither
- 6 - Monochrome error diffusion
- 7 - Cluster ordered dither
- 8 - Monochrome cluster ordered dither
- 9 - User-defined dither
- 10 - Monochrome user-defined dither
- 11 - Ordered dither
- 12 - Monochrome ordered dither
- 13 - Noise ordered dither
- 14 - Monochrome noise ordered dither
- 15 - Continuous tone smooth 150 lpi

- 16 - Monochrome continuous tone detail 300 lpi
- 17 - Monochrome continuous tone smooth 150 lpi
- 18 - Continuous tone basic 100 lpi
- 19 - Monochrome continuous tone basic 100 lpi

Default = 3

Range = 0 to 19 (invalid values are ignored; values 1, 2, 9, and 10 are ignored for device independent color)

Snap to Primaries

This algorithm converts each component of a color specification to its corresponding primary color. For example, assuming 8 bits per primary, an RGB input value greater than 128 snaps to 255; a value less than or equal to 128 snaps to 0.

Snap Black to White, Colors to Black

Choosing this option converts black to white and all other colors to black. Input primary colors equal to a black specification are converted to a white specification, and other color specifications for the input primaries are converted to the black specification.

Device Best Dither

This dither pattern produces the best results for many images. Note, however, that the recommended dither pattern varies with the image, the intended use of the image, and the subjective judgements of the user.

Error Diffusion

The input primaries of a given pixel (x,y) are printed at the closest density available and the local error is propagated to the unprinted neighboring pixels. Error diffusion applies only to raster data printed using the Configure Image Data command.

Ordered Dither and Clustered Ordered Dither

The ordered dither or cluster ordered dither causes a pixel to be intensified at a point (x,y) depending on the desired intensity, I(x,y), and on an n x n dither matrix, D, where:

$$i = x \text{ modulo } n$$

$$j = y \text{ modulo } n$$

For RGB color spaces, if $I(x,y) < D(i, j)$, the point corresponding to (x,y) is intensified; otherwise it is not. The intensity of each primary color is determined according to this scheme. The relationship between I and D depends on the specified color space.

Monochrome Rendering

Monochrome rendering generates a gray value from the three primary colors. The gray value is computed according to the NTSC standard, which for the Device RGB color space is:

$$\text{Gray} = 0.3 \times \text{Red} + 0.59 \times \text{Green} + 0.11 \times \text{Blue}$$

User-Defined Dithering

For a user-defined dither, the input primaries are compared against differently dimensioned dithers (e.g. MxN), which may vary for each primary color.

Note

Render algorithms 1, 2, 9 and 10 are not accessible when in a device-independent color space because it is impossible to characterize a printer for all possible dither algorithms. If one of these render algorithms is selected when in a device-independent color space, the device best dither algorithm will be used instead.

HP Color LaserJet 5 and 5M printers do not support user-defined dithering.

Non-Continuous Tone Algorithms

HP Color LaserJet 5 and 5M printers remap non-continuous tone render algorithms into continuous tone algorithms. The following remapping takes place:

Snap to primaries	=	Snap to primaries
Snap black to white, color to black	=	Snap black to white, color to black
Device best dither	=	Continuous tone smooth 150 lpi
Error diffusion	=	Continuous tone smooth 150 lpi
Monochrome device best dither	=	Monochrome continuous tone smooth 150 lpi
Monochrome error diffusion	=	Monochrome continuous tone smooth 150 lpi
Cluster ordered dither	=	Continuous tone smooth 150 lpi
Monochrome cluster ordered dither	=	Monochrome continuous tone smooth 150 lpi
User-defined dither	=	Continuous tone smooth 150 lpi
Monochrome user-defined dither	=	Monochrome continuous tone smooth 150 lpi
Ordered dither	=	Continuous tone smooth 150 lpi
Monochrome ordered dither	=	Monochrome continuous tone smooth 150 lpi
Noise ordered dither	=	Continuous tone smooth 150 lpi
Monochrome noise ordered dither	=	Monochrome continuous tone smooth 150 lpi

User-Defined Dithers

The Download Dither Matrix command ($E_c^*m\#W$) can create a dither matrix for one or all three primary colors, in effect providing halftone screens. User-defined dither matrices can be used for optimizing the printer's output capabilities when using device-dependent color spaces. They are ignored for device-independent color spaces, since the printer cannot be calibrated as is necessary for device-independent color. User-defined halftones can be downloaded for each component of the color space.

A user-defined matrix is defined in additive colors (RGB values). The dither matrix pixels are defined in terms of device-dependent resolution.

When using the Download Dither Matrix command, you have several options:

- You can choose whether to define a separate matrix for each color plane, or use the same matrix for all three color planes.
- You set the height and width of the dither cell. When using separate matrices for each plane, you can use different size dither cells for each plane. For example, you can have a 4 x 4 pixel cell for red, a 4 x 6 cell for green, and a 6 x 8 cell for blue.
- You download the data bytes for each pixel of the cell. Each data byte determines a threshold—every pixel with a value greater than or equal to the threshold gets turned on and every pixel with a value less than the threshold does not get turned on.

Note

HP Color LaserJet 5 and 5M printers do not support user-defined dithers. When a Download Dither Matrix command is sent, the printer parses and discards the matrix data and selects the continuous tone smooth 150 lpi algorithm instead.

Download Dither Matrix Command

The Download Dither Matrix command specifies a single matrix for all three primary colors, or three matrices (one for each primary), which may have different sizes and contents.

$E_C^*m\#W[data]$

= Number of bytes of byte-aligned binary data in the data field

Default = 0

Range = 7 to 32767 (command is ignored for values of 0 – 6; values larger than 32767 or device limits are clamped; signs are ignored)

A downloaded user-defined dither will not take effect until after explicitly selecting it via a render algorithm command with a value of 9 or 10. However, if the current render algorithm (or last render algorithm received) was a user-defined algorithm (value 9 or 10), then a user-defined matrix will take effect as soon as it is downloaded. In this case, another render algorithm command (value 9 or 10) is not needed to “select” the downloaded user-defined dither matrix. This is due to the fact that the downloaded user-defined dither algorithm is the currently selected render algorithm.

If the command is sent before downloading a user-defined dither matrix, the device will use the device’s user-defined dither default, if available, or, if no default is available, will use the default render algorithm.

Note

The user-defined dither matrix must be defined for processing with additive colors (RGB).

Since user-defined algorithms cannot be used when a device-independent color space is active, trying to specify a user-defined algorithm in this situation causes the default algorithm to be used. The default is used until the algorithm is changed to something other than user-defined, or until you specify a device-dependent color space.

The table below shows the format for a dither matrix that is applied to all three color primaries. The format for “multiple dither matrices” is supplied after this explanation. (“uint 16” means unsigned 16-bit integer; “ubyte” means unsigned byte.)

Byte	15 (msb)	8	7	(lsb) 0	Byte
0	Format = 0		Number of planes = 1		1
2	Dither matrix height in pixels (uint 16)				3
4	Dither matrix width in pixels (uint 16)				5
6	byte #0 (ubyte)		byte #1 (ubyte)		7
8	byte #2 (ubyte)		byte #3 (ubyte)		9
	•				
	•				

Format

This byte should be set to 0.

Number of Planes

This byte designates how many dither matrices are specified by the command. The command is ignored and the data discarded for any value other than 1 or 3.

Byte Value	Value Description
1	One matrix applied to all primaries
3	Each primary has a separate matrix

Height and Width

These bytes designate the size of the dither matrix in pixels. For example, a value of four for height and six for width produces a dither cell that is four pixels wide by six pixels high. Values must be non-zero and sized so the matrix contains no more than 32767 bytes.

Otherwise, the command is ignored and the data discarded. The minimum dither matrix size is 1 x 1.

Data Bytes

After specifying the height and width of the cell, data bytes are sent row-by-row (row-major order). Each data byte contains the normalized probabilities, ranging from 0 to 255, of one cell.

For example, a 2 x 2 cell could have no pixels print for RGB values of 205 through 255, one pixel for values of 153 through 204, two pixels from 101 through 152, three pixels for 49 through 100, and all four pixels between 0 and 48 (see the illustration below, which represents a halftone cell for one of the primary colors—note that the color data is in RGB values).

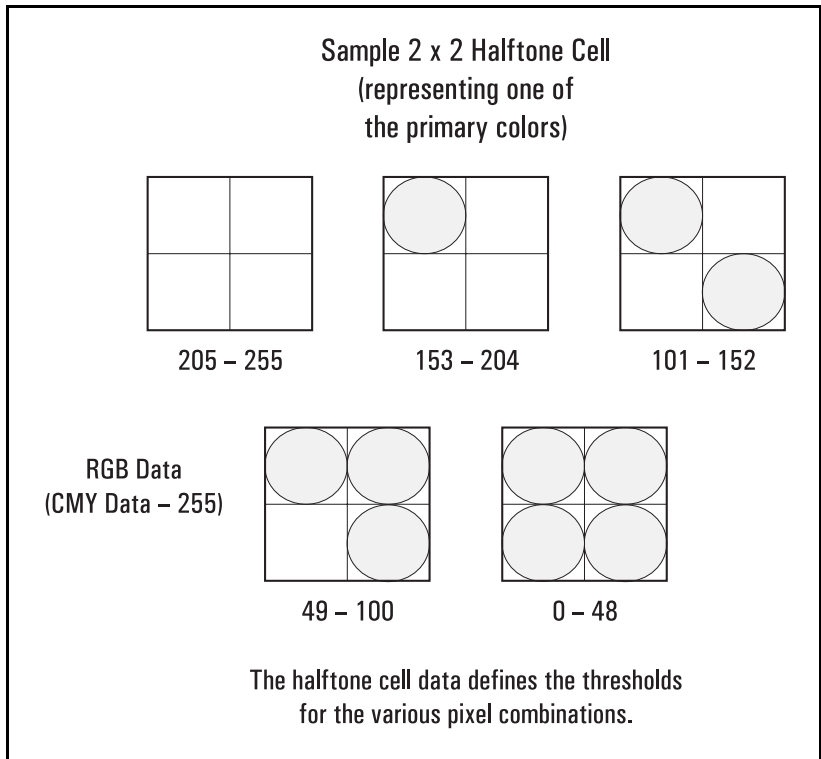

Each dither matrix must be completely specified. Otherwise, the width and height values may be misinterpreted if multiple matrices are sent.

If the width, height, and data specifications result in an odd number data bytes, the next matrix specification will begin on an odd byte boundary. No padding is provided for even-byte aligning.

Multiple Dither Matrices

As noted in the previous table, you set the number of planes field to 3 to send separate matrices for each primary. Each dither matrix must have its own width and height data fields. As shown below, the matrix specification for each primary follows the previous primary color's matrix specification.

Byte	15 (msb)	8	7	(lsb) 0	Byte
0	Format = 0		Number of planes = 3		1
2	Dither matrix height in pixels (uint 16)				3
4	Dither matrix width in pixels (uint 16)				5
6	byte #0 (ubyte)		byte #1 (ubyte)		7
8	byte #2 (ubyte)		byte #3 (ubyte)		9
	•				
	•				
n	Dither matrix height in pixels (uint 16)				n + 1
n + 2	Dither matrix width in pixels (uint 16)				n + 3
n + 4	byte #0 (ubyte)		byte #1 (ubyte)		n + 5
n + 6	byte #2 (ubyte)		byte #3 (ubyte)		n + 7
	•				
	•				
m	Dither matrix height in pixels (uint 16)				m + 1
m + 2	Dither matrix width in pixels (uint 16)				m + 3
m + 4	byte #0 (ubyte)		byte #1 (ubyte)		m + 5
m + 6	byte #2 (ubyte)		byte #3 (ubyte)		m + 7

Example

This example produces a 4 x 4 dither matrix that is applied to all three color primaries (the number of planes is set to 1). The following command would be sent to create this dither matrix:

$\text{E}_C^*m22W010404B0B1B2B3B4 \dots B15$ (where the first 6 binary bytes are shown as ASCII here for clarity, and B1 . . . B15 indicate the binary byte data).

The byte-aligned binary data field (shown as ASCII for clarity) would be:

Byte	15 (msb)	8	7	(lsb) 0	Byte
0	0		1		1
2	0		4		3
4	0		4		5
6	B0		B1		7
8	B2		B3		9
	•				
	•				
20	B14		B15		21

Note

Do not use downloaded dither matrices as patterns since the orientation of the pattern will not rotate with changes in orientation and page rotation.

Note

HP Color LaserJet 5 and 5M printers do not support the Download Dither Matrix command. When this command is sent, the printer parses and discards the matrix data. The printer selects the Continuous Tone Smooth 150 lpi algorithm instead.

Color Lookup Tables

Color lookup tables provide a way to re-map color data for the following types of applications:

- Highlight and shadow modification
- Saturation and desaturation
- Unique gamma correction curves
- Special effects for tonal correction
- Neutral balancing

Color lookup tables map input data for each primary color into a new output range based on point-by-point conversions. Color lookup tables can modify input data for both device-dependent and device-independent color spaces.

Like the CID command, the first byte of the data field identifies the color space to which the lookup tables will be applied. These tables specify on a point-per-point basis a transformation from an input space of 0 . . . 255 into an output space of 0 . . . 255. Figure D-1 on the next page illustrates the concept.

The *unity lookup table* (see the following illustration) is the default for all color spaces; it performs a 1:1 mapping of input to output (that is, 129 is mapped to 129). The inversion lookup table performs a simple color inversion; for example, it inverts the red primary of a device-dependent RGB color space to create cyan output (from 255 red to 0 red, which is 255 cyan).

Color Lookup Tables Command

This command enables and specifies color lookup tables.

$E_C^*l\#W[*binary data*]$

= Number of bytes of binary data

Default = 0

Range = 0 or 770 (command is ignored for other values; sign is ignored)

A value of 0 resets or initializes the color lookup tables for each primary to the unity curve (1:1). A value of 770 means the data for a color lookup table will be following. The command is ignored and the data is absorbed for any number of bytes not equal to 0 or 770.

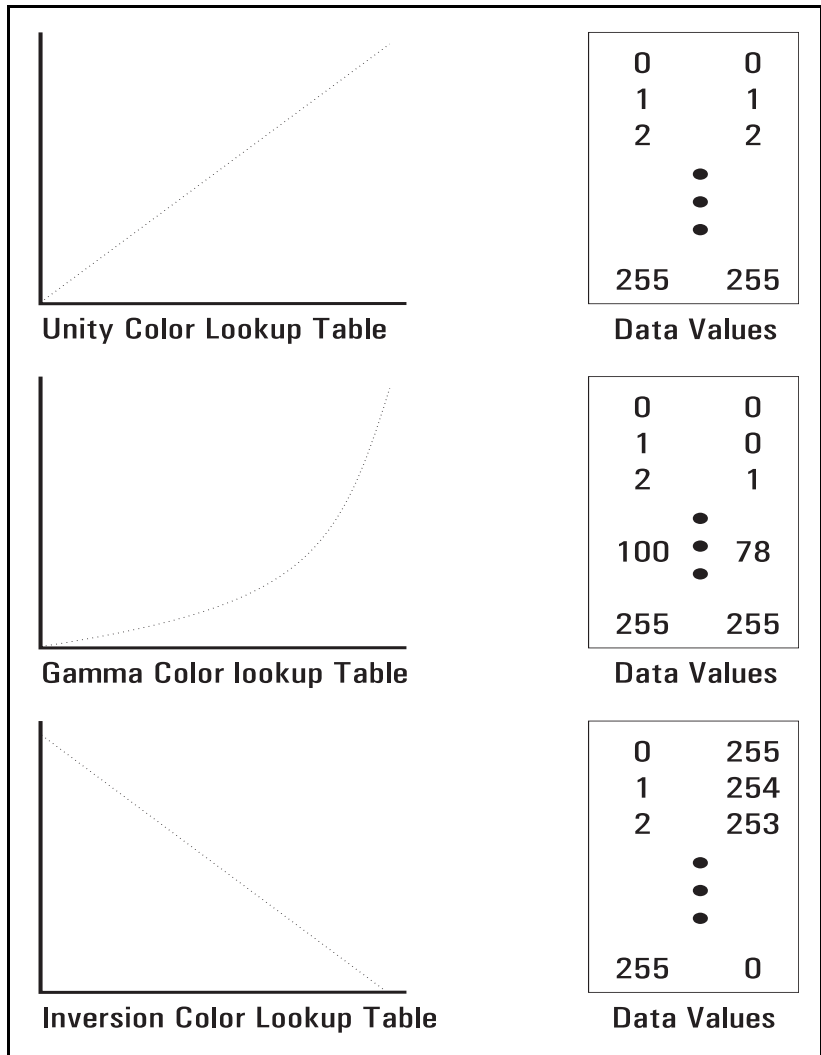

Figure D-1 Color Lookup Tables

This command enables the color lookup tables until an E_cE , Configure Image Data (CID), or another Color Lookup Tables command with a 0 value field is received.

Note

RGB gamma correction ($E_c*t\#l$) and color lookup tables for device-dependent color spaces are mutually exclusive and overwrite each other.

As shown below, the 256 point-by-point transformation curve for each primary color is defined sequentially for a total of 768 bytes, with the additional 2 bytes for specifying the color space and reserved data field.

Byte	15 (msb)	8 7	(lsb) 0	Byte
0	Color Space	Reserved Data Field		1
2	Color Component 1, Index 1	Color Component 1, Index 2		3
4	Color Component 1, Index 3	Color Component 1, Index 4		5
...				
256	Color Component 1, Index 255	Color Component 1, Index 256		257
258	Color Component 2, Index 1	Color Component 2, Index 2		259
260	Color Component 2, Index 3	Color Component 2, Index 4		261
...				
512	Color Component 2, Index 255	Color Component 2, Index 256		513
514	Color Component 3, Index 1	Color Component 3, Index 2		515
516	Color Component 3, Index 3	Color Component 3, Index 4		517
...				
768	Color Component 3, Index 255	Color Component 3, Index 256		769

Byte 0 (Color Space)

Value	Color Space
0	Device RGB (default)
1	Device CMY
2	Colorimetric RGB Spaces
3	CIE L*a*b*
4	Luminance-Chrominance Spaces

A color lookup table can be attached to one or more of the color spaces anytime after a CID command. For example, a Luminance-Chrominance space can have four lookup tables specified, namely:

- Device-Dependent space
- CIE L*a*b* space
- Colorimetric RGB space
- Luminance-Chrominance space

A reset (E_{cE}), IN, or CID command sets each of the four levels of color lookup tables for each primary to the unity curve.

Gamma Correction

Color monitors, which are by nature non-linear, appear incorrect when given a linear ramp of some color. Gamma correction can significantly improve perceptual correctness by adjusting the brightness or darkness of the color data sent from the monitor to any other non-linear device.

Gamma Correction Command

$E_C^*t\#l$

= Gamma number

Default = 0 (gamma correction off)

Range = 0.0 to 32767.0 (command is ignored for invalid values)*

* The practical range for gamma values is 0.0 to 4.0.

Assuming 8 bits per primary (256 intensity levels per primary), the corrected intensity for each color primary is calculated as follows:

$$\text{Intensity} = 255 * \left\{ \frac{\text{Input}}{255} \right\}^{\frac{1}{\gamma}}$$

Gamma correction is referred to in terms of device- dependent RGB. This command does not destroy the contents of device-dependent color lookup tables, but setting a gamma value supersedes any lookup table input in either Device CMY or Device RGB.

Note

The default value (0) gives the same result as a gamma value of 1.0, which results in a unity gamma curve.

Viewing Illuminant

Printed colors undergo a hue shift when viewed under different illuminations (for example, fluorescent, tungsten, or daylight). Colors with spectral characteristics outside the range of an illumination source are not received, changing the appearance of mixed colors. The Viewing Illuminant command ($E_c*i\#W$) supports communication of standard illuminations to the printer to allow the printer to compensate for different lighting conditions when appearance matching.

Viewing Illuminant Command

The Viewing Illuminant command specifies the relative white point used in the determination of a viewing illuminant condition.

$E_c*i\#W$ [*binary data*]

= Number of binary bytes of data

Default = 8

Range = 8 (command is ignored for invalid values; signs in the value field are ignored)

The binary data field is formatted as follows:

Byte	15 (msb)	8	7	(lsb) 0	Byte
0	x chromaticity white point (lsw)				1
2	x chromaticity white point (msw)				3
4	y chromaticity white point (lsw)				5
6	y chromaticity white point (msw)				7

The above format adheres to the IEEE floating point format as follows:

31	30	23	22	0
Sign	Exponent		Fractional Portion	

The PCL default viewing illuminant is D65 (6500K). Below is a table of viewing illuminants and their chromaticity values.

Illuminant	x chromaticity	y chromaticity
Daylight (D65) (6500K)	0.3127	0.3290
Tungsten (3200K)	0.4476	0.4074
Cool White Fluorescent (5630K)	0.3904	0.3914

This command affects only device-independent color. The command acts like a state variable: it is ignored for White/Black, Device RGB, or Device CMY palettes, but it becomes active when a new CID command specifies a device-independent color space.

Monochrome Printing

The *Monochrome Print Mode* command converts each color value to its grayscale equivalent. This improves throughput, costs less to print, and eliminates waste by providing a draft mode.

Monochrome Print Mode Command

The Monochrome Print Mode command designates whether to print using the current rendering mode or a fast gray-scale equivalent. Pages printed using the gray-scale equivalent do not use any color and therefore print faster and more economically.

$E_C&b\#M$

- # = 0 - Print in mixed render algorithm mode
- 1 - Print using gray-scale equivalent

Default = 0

Range = 0, 1 (command is ignored for invalid values)

This command must be sent prior to printable data; otherwise, the current page is closed and printed. It may be sent on a page-by-page basis.

Driver Configuration Command

This command specifies the Lightness, Saturation, and Scaling Algorithm to be applied to the document, and allows for the selection and downloading of Color Maps.

$E_C^*o\#W[device_id\ function_index\ Arguments]$

= Specifies the number of bytes to follow (device ID function index arguments)

Default = N/A

Range = see description below

device_id

Value	Printer
6	Color LaserJet printer

function_index

function_index	Description	Argument Range	
0	Lightness	-100 to 100	
1	Saturation	-100 to 100	
3	Scaling Algorithm	0	Pixel Replication
		1	Bilinear Interpolation
		2	Modified Bilinear Interpolation
4	Select Color Treatment	0	No Adjustment ¹
		1	Process Blue ¹
		2	Vivid Graphics ¹
		3	Transparency
		4	Out of Gamut
		5	CIE Lab Match
		6	Screen Match

function_index	Description	Argument Range	
5	Download Color Map	1	CMY Color Space
		3	CIE Lab Color Space
		<i>See MapID List (14739 bytes)</i>	

¹ For the original Color LaserJet printer, the color treatment arguments were slightly different: (0 — Process Blue, 1 — Vivid, and 2 — Business Blue).

The following paragraphs describe the *function_index* values and their arguments.

Lightness

Negative values darken (unlighten) the image, text or graphics color, but do not have any effect on black or white data. Positive values lighten the image. Zero turns the lightness adjustment off. This function index requires three data bytes.

Saturation

Negative values desaturate (add gray to) the image, text or graphics color, but will not have any effect on black or white data. Positive values increase the amount of saturation, making the image more vivid. Zero turns the saturation adjustment off. This function index requires three data bytes.

Scaling

Pixel replication is a backward-compatible scaling algorithm. Bilinear interpolation is a high-quality scaling algorithm for smooth-edge interpolated scaling. Modified bilinear scaling only interpolates when it is best to do so. This function index requires three data bytes.

Select Treatment

This value specifies which color treatment mode to use for rendering the next job.

No Adjustment

This setting provides linearization only (that is, the user sees the device as a linear device).

Process Blue

This setting provides the same results as Vivid Graphics (linearization plus user-preferred enhancements) with the addition of mapping process blue, which looks slightly purple, to a blue closer to that of a standard monitor. This setting is not supported by HP Color LaserJet 5 and 5M printers.

Vivid Graphics

This setting adds color saturation to the resulting image.

Transparency

This setting uses a map to render the best color output on transmissive media. This setting is not supported by HP Color LaserJet 5 and 5M printers.

Out of Gamut

This setting prints colors in an image that are out of gamut—all colors that are in gamut snap to white, all out-of-gamut colors are snapped to the gamut surface. This setting only supports the device-independent color map. This setting is not supported by HP Color LaserJet 5 and 5M printers.

CIE L*a*b* Match

This map performs a true color match to the requested CIE L*a*b* input (there are no appearance matching adjustments). This setting only supports the device-independent color map. This setting is not supported by HP Color LaserJet 5 and 5M printers.

Screen Match

This setting produces a simulated Colorimetric RGB effect of device independent color to match the color to a Sony Trinitron monitor while operating out of a device dependent color space. This setting is supported only by HP Color LaserJet 5 and 5M printers.

Note

For screen matching, the long form of the Configure Image Data command is used and the color maps are generated internally dependent upon the monitor calibration data (the Driver Configuration command is not needed).

Download Color Map

The printer supports the downloading of color adjustment maps dependent upon the halftone requested, the type of color treatment desired (including device-dependent or independent), and the type of media.

Setting	Description	MapID
Device Dependent		
No adjustment	Cluster-No Adjust-DD	1
	Disperse-No Adjust-DD	2
	Scatter-No Adjust-DD	3
	ErrorDiffusion-No Adjust-DD	4
Process Blue	Cluster-Process Blue-DD	5
	Disperse-Process Blue-DD	6
	Scatter-Process Blue-DD	7
	ErrorDiffusion-Process Blue-DD	8
Transparency	Cluster-Transparency-DD	9
	Disperse-Transparency-DD	10
	Scatter-Transparency-DD	11
	ErrorDiffusion-Transparency-DD	12
Vivid Graphics	Cluster-VividGraphics-DD	13
	Disperse-VividGraphics-DD	14
	Scatter-VividGraphics-DD	15
	ErrorDiffusion-VividGraphics-DD	16

Setting	Description	MapID
Out of Gamut	Cluster-OutOfGamut-DD	17
	Disperse-OutOfGamut-DD	18
	Scatter-OutOfGamut-DD	19
	ErrorDiffusion-OutOfGamut-DD	20
CIELab Match	Cluster-TrueMatch-DD	21
	Disperse-TrueMatch-DD	22
	Scatter-TrueMatch-DD	23
	ErrorDiffusion-TrueMatch-DD	24

Setting	Description	MapID
Device-Independent		
No Adjustment	Cluster-No Adjust-DI	51
	Disperse-No Adjust-DI	52
	Scatter-No Adjust-DI	53
	ErrorDiffusion-No Adjust-DI	54
Process Blue	Cluster-Process Blue-DI	55
	Disperse-Process Blue-DI	56
	Scatter-Process Blue-DI	57
	ErrorDiffusion-Process Blue-DI	58
Transparency	Cluster-Transparency-DI	59
	Disperse-Transparency-DI	60
	Scatter-Transparency-DI	61
	ErrorDiffusion-Transparency-DI	62
Vivid Graphics	Cluster-VividGraphics-DI	63
	Disperse-VividGraphics-DI	64
	Scatter-VividGraphics-DI	65
	ErrorDiffusion-VividGraphics-DI	66
Out of Gamut	Cluster-OutOfGamut-DI	67
	Disperse-OutOfGamut-DI	68
	Scatter-OutOfGamut-DI	69
	ErrorDiffusion-OutOfGamut-DI	70
CIELab Match	Cluster-TrueMatch-DI	71
	Disperse-TrueMatch-DI	72
	Scatter-TrueMatch-DI	73
	ErrorDiffusion-TrueMatch-DI	74

Index

A

- adaptive compression
 - block size 6-28, 6-31
 - compression methods 6-29
 - control bytes 6-29
 - cursor position 6-31
 - data block 6-28
 - delta row 6-29, 6-31
 - duplicate row 6-29, 6-30, 6-31
 - empty row 6-29, 6-30, 6-31
 - format 6-29
 - operation hints 6-31
 - row length 6-31
 - run-length encoded 6-29, 6-31
 - seed row 6-31
 - TIFF 6-29, 6-31
 - y-offset 6-31
- area fill ID command
 - See also pattern ID command 5-29
- area fill, user-defined patterns 5-33
- assign color index command 3-20, C-21

B

- base pattern 5-33
- black and white references A-4
- black rule 5-32
- black-and-white mode 2-1, B-2
- block size, adaptive compression 6-28
- byte counts 6-34

C

- chapter summary iv
- CIE L*a*b* color space B-18
- clipping raster area 6-13
- coding efficiency, raster compression 6-23
- color
 - concepts A-3
 - device-dependent A-2, A-4, A-10
 - device-independent A-2, A-4, A-10
 - foreground 3-17, C-18
 - lookup tables A-12, D-13
 - map 4-4, D-22
 - matching A-11
 - modes A-7
 - modifying output 4-1, D-1
 - processing documents A-14
 - raster vs. non-raster A-3, A-14

- selection A-5
- color appearance matching A-12
- color component one command 3-19, C-20
- color component three command 3-20, C-21
- color component two command 3-19, C-20
- color lookup tables A-2
- color lookup tables command D-13
- color management 1-4
- color modes
 - black-and-white mode 2-1, B-2
 - HP-GL/2 imaging mode 2-2, 2-13, B-3, B-28
 - PCL imaging mode 2-2, 2-5, B-2, B-6
 - simple color mode 2-1, 2-3, B-2, B-4
- color print model
 - command sequence 5-6
 - logical operations and transparency 5-12
 - rectangular area fills 5-45
- color printing overview 1-1, A-1
- color range (CR) command 7-19
- color selection and palettes 1-6
- color spaces 1-3
- color specifications 1-3
- color vector graphics (HP-GL/2) 7-1
- Colorimetric RGB color space B-20
- command
 - finish mode 4-6
 - logical operation 5-13
 - pixel placement 5-27
- commands, PCL
 - EC#c#G - Pattern (Area Fill) ID 5-29
 - End Raster Graphics 6-35
 - pattern control 5-44
 - pattern ID 5-29
 - pattern transparency mode 5-8
 - raster graphics presentation 6-10
 - raster graphics resolution 6-8
 - raster graphics, start 6-17
 - Raster Height command 6-13
 - Raster Width command 6-15
 - raster y offset 6-19
 - Select Current Pattern command 5-32
 - Set Pattern Reference Point 5-43
 - Set Raster Compression Method 6-20
 - Source Transparency Mode 5-7

- transfer raster data 6-32
- user-defined pattern 5-38
- compression
 - adaptive 6-29
 - adaptive (operation hints) 6-31
 - byte counts 6-34
 - delta row 6-20, 6-24, 6-27
 - raster data 6-15, 6-23
 - run-length 6-21
 - TIFF 6-21
 - TIFF, raster data 6-20
- compression method
 - adaptive 6-28
 - delta row 6-24
 - run-length encoding 6-21
 - setting 6-20
 - TIFF 6-21
 - unencoded 6-21
- Configure Image Data (CID) command
 - 2-5, B-6
 - examples B-25
 - long form B-17
 - short form B-15
- continuation, user-defined pattern
 - descriptor 5-39
- control bytes, adaptive compression 6-29
- CR (color range) command 7-19
- cross-hatch patterns selection 5-29
- current pattern 5-2
- Current Pattern command 5-32
- cursor positioning
 - adaptive compression 6-31
 - raster graphic 6-34

D

- data block, adaptive compression 6-28
- data compression, raster data 6-15
- data range scaling B-16
- data, user-defined pattern 5-39
- default palettes 3-15, C-16
- delta row compression
 - adaptive compression 6-29, 6-31
 - raster graphics 6-20, 6-24
- descriptor, user-defined pattern header
 - 5-38
- destination image 5-2
- destination raster height command 6-37
- destination raster width command 6-37
- device CMY color space B-18
- device RGB color space B-17
- device-dependent color A-10
- device-independent color A-10
- direct color selection A-5
- dither patterns 4-2, D-3
 - user-defined dithers D-6

- dithers
 - download dither matrix command D-7
 - multiple dither matrices D-10
 - download dither matrix command D-7
 - download pattern command 5-38
 - driver configuration command 4-4, D-21
 - duplicate row, adaptive compression 6-29

E

- empty row, adaptive compression 6-29
- encoding
 - by pixel A-7
 - by plane A-6
- end raster graphics command 6-35
- enter HP-GL/2 mode 7-2
- escape sequences (PCL)
 - EC*b#M - Set Compression Method 6-20
 - EC*b#Y - Raster Y Offset 6-19
 - EC*c#Q - Pattern Control 5-44
 - EC*c#W - User-Defined Pattern 5-38
 - EC**l* # R - Pixel Placement Command 5-27
 - EC**l*#O - Logical Operation 5-13
 - EC*p#R - Set Pattern Reference Point 5-43
 - EC*r#F - Raster Graphics Presentation 6-10
 - EC*r#T - Raster Height 6-13
 - EC*r#T - Raster Width 6-15
 - EC*t#R - Raster Graphics Resolution 6-8
 - EC*v#N - Source Transparency Mode 5-7
 - EC*v#O - Pattern Transparency mode 5-8
 - EC*v#T - Select Current Pattern Command 5-32

F

- Faster Y Offset command 6-19
- fill rectangular area command 5-48
- finish mode command 4-6
- foreground color 5-2
- foreground color command 3-17, C-18
- format field, user-defined pattern
 - descriptor 5-38

G

- gamma correction A-2, D-17
- gamma correction command D-17
- graphic patterns 5-29
- graphics
 - raster 6-1
 - special effects 5-1

- transparency mode 5-2
- user-defined patterns 5-33
- grid centered, pixel 5-27
- grid intersection, pixel 5-27

H

- halftone render algorithms 4-2, A-2, D-3
- height
 - pixels, user-defined pattern descriptor 5-39
- Horizontal Rectangle Size command 5-46
- HP-GL/2 graphics 7-1
- HP-GL/2 imaging mode 2-2, 2-13, B-3, B-28
- HP-GL/2 pixel placement command 7-22

I

- ICC profiles 1-4
- illumination models A-13
- image, raster 6-1
- indexed color selection A-5

L

- logical operation command 5-13
- logical operations 5-3, 5-9
 - and transparency interactions 5-12
- long form CID command B-17
- luminance-chrominance color space B-22

M

- manual organization iv
- matching color A-11
- MC (merge control) command 7-6
- memory, raster graphics usage 6-8
- merge control (MC) command 7-6
- monochrome print mode command 4-3, D-20
- monochrome printing 4-3, D-20

N

- NP (number of pens) command 7-17
- number of pens (NP) command 7-17

O

- operations, logical 5-9
- orientation, raster graphics 6-10
- overview 1-1, A-1

P

- page-marking primitives A-14
- palette control ID 3-8, C-8
- palette, select 3-6, C-6
- palettes 3-1, A-1, A-3, C-1
 - CID color 3-13, C-13

- control 3-9, C-9
- Control ID 3-8, C-8
- default 3-15, C-16
- device CMY 3-14, C-15
- device RGB 3-13, C-13
- device-independent 3-14, C-15
- HP-GL/2 3-15, C-16
- management by ID 3-5, C-5
- palette stack 3-5, C-5
- palette store 3-5, C-5
- programming 3-19, C-20
- saving 3-3, C-3
- select palette command 3-6, C-6
- simple color 3-11, C-11
- palettes and color selection 1-6
- pattern
 - current 5-2
 - reference point 5-36
 - shading 5-30
 - user-defined 5-33
- pattern control command 5-44
- patterns 5-44
- Pattern ID (Area Fill ID) command 5-29
- pattern transparency 5-50
- pattern transparency mode 5-3
- Pattern Transparency Mode command 5-8
- patterns 5-2
 - download pattern command] 5-38
 - filling with 5-28
 - reference point 5-36
 - select current pattern command 5-32
 - set pattern reference point command 5-43
 - tiling 5-34
 - user-defined patterns 5-33
- PC (pen color) command 7-14
- PCL 5 color concepts 1-3
- PCL 5 color graphics context 1-6
- PCL 5 color mode 1-6
- PCL 5 Comparison Guide vi
- PCL 5 raster images 1-7
- PCL imaging mode 2-2, 2-5, B-2, B-6
- PCL print model 5-1
- PCL/PJL Technical Quick Reference Guide vi
- pen color (PC) command 7-14
- pixel encoding A-6, A-7
 - user-defined pattern descriptor 5-39
- pixel placement 5-24, 5-27
 - command 5-27
 - HP-GL/2 command 7-22
 - PCL command 5-27
- pixel placement (PP) command 7-20, 7-22
- pixel placement command 5-27

- pixels and pixel encoding 1-7
 - plane encoding A-6
 - position, rectangular area 5-49
 - PP (pixel placement) command 7-20, 7-22
 - PP command, HP-GL/2 7-22
 - primitives A-14
 - print model A-1
 - command sequence 5-6
 - current pattern 5-2
 - destination image 5-1
 - logical operations and transparency 5-12
 - pattern 5-1
 - pattern ID (area fill ID) command 5-29
 - pattern transparency mode 5-2, 5-8
 - rectangular area fills 5-45
 - rectangular areas, pattern ID command 5-29
 - Select Current Pattern command 5-32
 - source image 5-1
 - source transparency mode 5-2
 - printable area (raster graphics) 6-7
 - printing
 - patterns/shading 5-29
 - raster graphic resolution 6-8
 - push/pop palette command 3-3, C-3
- R**
- raster graphics 6-1, 6-7
 - adaptive compression 6-28
 - clipping 6-13
 - command sequence 6-6
 - compression 6-20, 6-27
 - compression (example) 6-23, 6-27
 - compression, byte counts 6-34
 - compression, coding efficiency 6-23
 - compression, TIFF Encoding 6-21
 - data block 6-28
 - data compressions/reduction 6-15
 - delta row compression 6-20, 6-24
 - End command 6-35
 - end raster graphics command 6-35
 - Height command 6-13
 - image 6-1
 - left margin 6-17
 - memory usage 6-8
 - orientation 6-10
 - presentation 6-17
 - presentation mode 6-17
 - printable area 6-7
 - printing zeroed row 6-27
 - raster area height 6-13
 - raster graphics presentation mode command 6-10
 - Raster Y Offset command 6-19
 - repeating row 6-27
 - resolution 6-17
 - run-length data compression 6-20, 6-21
 - seed row 6-26
 - Set Compression Method command 6-20
 - Start command 6-17
 - termination command 6-35
 - termination implied 6-17
 - TIFF data compression 6-20
 - Transfer Raster Data command 6-32, 6-33
 - Width command 6-15
 - zeroed rows 6-5
 - raster graphics presentation mode command 6-10
 - raster graphics resolution command 6-8
 - raster height command 6-13
 - raster image 6-1
 - raster mode A-3
 - raster scaling 6-36
 - raster vs. non-raster color A-14
 - raster width command 6-15
 - Raster Y Offset command 6-19
 - rectangle
 - fill (transparency mode) 5-50
 - Horizontal Size command 5-46
 - position 5-49
 - transparency mode 5-49
 - Vertical Rectangle Size command 5-47
 - rectangular area fill examples 5-52
 - rectangular area fills 5-45
 - related documents vi
 - render algorithm command 4-2, D-3
 - render algorithms 4-2, A-2, D-3
 - resolution, raster graphics printing 6-8
 - ROP 5-13
 - ROP3 logical operation 5-13
 - rows, zeroed (in raster graphics) 6-5
 - rule
 - black 5-32
 - white 5-32
 - rules 5-45
 - run-length
 - adaptive compression 6-29
 - raster graphics compression 6-20
- S**
- scaling, raster 6-36
 - seed row 6-24, 6-26
 - adaptive compression 6-31
 - raster graphic termination 6-17
 - Select Current Pattern command 5-32
 - Select Palette command 3-6, C-6
 - Set Compression Method command 6-20

- Set Pattern Reference Point command
 - 5-33, 5-43
- shaded fill
 - pattern selection 5-29
 - patterns 5-30
- short form CID command B-15
- Simple Color command 2-3, B-4
- simple color mode 2-1, 2-3, B-2, B-4
- source image 5-2
- source raster height command 6-13
- source raster width command 6-15
- source transparency mode 5-2
- Source Transparency Mode command
 - 5-7
- SP 6-13
- sRGB color space 1-4
- Start Raster Graphics command 6-17

T

- Tagged Image File Format (TIFF)
 - Encoding (raster compression)
 - 6-21
- texture 5-2
- TIFF
 - adaptive compression 6-29, 6-31
 - raster graphics compression 6-20
- Transfer Raster Data command 6-28,
 - 6-32, 6-33
- transparency interactions and logical operation 5-12
- transparency mode 5-2
 - rectangular area 5-49
 - source 5-7

U

- unencoded, adaptive compression 6-29
- user-defined dithers D-6
- user-defined pattern
 - assign ID 5-29
 - base pattern 5-33
 - data 5-38, 5-39
 - define pattern command 5-38
 - deleting 5-44
 - descriptor format (header) 5-38
 - example 5-40
 - header fields 5-38
 - introduction 5-33
 - Pattern Control command 5-44
 - permanent 5-44
 - reference point 5-36
 - selecting ID 5-29
 - Set Pattern Reference Point command
 - 5-43
 - temporary 5-44
 - tiling 5-34
- User-Defined Pattern command 5-38

- user-defined patterns 5-33

V

- Vertical Rectangle Size command
 - decipoints 5-47
 - PCL Units 5-47
- viewing illuminant A-2
- viewing illuminant command D-18

W

- well-behaved raster 1-9
- white rule 5-32
- width
 - pixel, user-defined pattern descriptor
 - 5-39

Y

- Y offset command 6-19
- Y-offset, adaptive compression 6-31

Z

- zeroed rows (in raster graphics) 6-5



Printed on
Recycled Paper

**Copyright© 1999
Hewlett-Packard Co.
Printed in USA**